

Digital Palmcorder® MultiCam™ Camcorder

Panasonic®

Operating Instructions Digital Video Camcorder

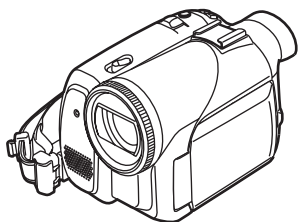

Model No. **PV-GS65**

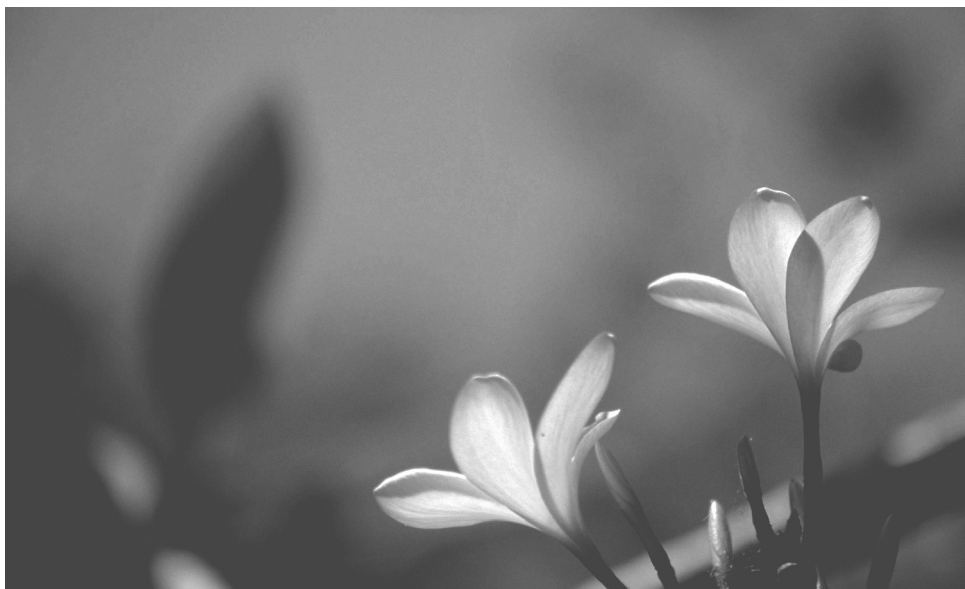

Before connecting, operating or adjusting this product,
please read the instructions completely.

Spanish Quick Use Guide is included.

Guía para rápida consulta en español está incluida.



For USA assistance, please call: 1-800-211-PANA(7262) or, contact us via the web at: <http://www.panasonic.com/contactinfo>

For Canadian assistance, please call: 1-800-561-5505 or visit us at www.panasonic.ca

LSQT0860 A

Things You Should Know

Thank you for choosing Panasonic!

You have purchased one of the most sophisticated and reliable products on the market today. Used properly, we're sure it will bring you and your family years of enjoyment. Please take time to fill in the information on the right.

The serial number is on the tag located on the underside of your Camcorder. Be sure to **retain this manual** as your convenient Camcorder information source.



Date of Purchase
Dealer Purchased From
Dealer Address
Dealer Phone No.
Model No.
Serial No.

Safety Precautions

WARNING: TO PREVENT FIRE OR SHOCK HAZARD, DO NOT EXPOSE THIS EQUIPMENT TO RAIN OR MOISTURE.

Your **Mini DV** Camcorder is designed to record and play back in Standard Play (SP) mode and Long Play (LP) mode

It is recommended that only cassette tapes that have been tested and inspected for use in Camcorder with the **Mini DV** mark be used.

 CAUTION RISK OF ELECTRIC SHOCK DO NOT OPEN		This symbol warns the user that uninsulated voltage within the unit may have sufficient magnitude to cause electric shock. Therefore, it is dangerous to make any kind of contact with any inside part of this unit.
CAUTION: TO REDUCE THE RISK OF ELECTRIC SHOCK, DO NOT REMOVE COVER (OR BACK) NO USER-SERVICEABLE PARTS INSIDE REFER SERVICING TO QUALIFIED SERVICE PERSONNEL		This symbol alerts the user that important literature concerning the operation and maintenance of this unit has been included. Therefore, it should be read carefully in order to avoid any problems.

AC Adaptor

- The rating plate is on the underside of the AC Adaptor.

FCC Note: This equipment has been tested and found to comply with the limits for a Class B digital device, pursuant to Part 15 of the FCC Rules. These limits are designed to provide reasonable protection against harmful interference in a residential installation. This equipment generates, uses, and can radiate radio frequency energy and, if not installed and used in accordance with the instructions, may cause harmful interference to radio communications. However, there is no guarantee that interference will not occur in a particular installation. If this equipment does cause harmful interference to radio or television reception, which can be determined by turning the equipment off and on, the user is encouraged to try to correct the interference by one or more of the following measures:

- Reorient or relocate the receiving antenna.
- Increase the separation between the equipment and receiver.
- Connect the equipment into an outlet on a circuit different from that to which the receiver is connected.
- Consult the dealer or an experienced radio/TV technician for help.

FCC Caution: To assure continued compliance, follow the attached installation instructions and use only shielded interface cables with ferrite core when connecting to computer or peripheral devices. Any changes or modifications not expressly approved by the party responsible for compliance could void the user's authority to operate this equipment.

Declaration of Conformity

Trade Name: Panasonic

Model No.: PV-GS65

Responsible party: Panasonic Corporation of North America
One Panasonic Way, Secaucus, NJ 07094

Support Contact: Panasonic Consumer Electronics Company
1-800-211-PANA (7262)

This device complies with Part 15 of the FCC Rules. Operation is subject to the following two conditions: (1) This device may not cause harmful interference, and (2) this device must accept any interference received, including interference that may cause undesired operation.

CAUTION: TO PREVENT FIRE OR SHOCK HAZARD AND ANNOYING INTERFERENCE, USE THE RECOMMENDED ACCESSORIES ONLY.

CAUTION: DANGER OF EXPLOSION IF BATTERY IS INCORRECTLY REPLACED. REPLACE ONLY WITH THE SAME OR EQUIVALENT TYPE.

- Since this product gets hot during use, operate it in a well ventilated place; do not install this equipment in a confined space such as a bookcase or similar unit.

 WARNING

AS WITH ANY SMALL OBJECT, SD CARDS CAN BE SWALLOWED BY YOUNG CHILDREN. DO NOT ALLOW CHILDREN TO HANDLE THE SD CARD.

IMPORTANT SAFETY INSTRUCTIONS

- 1) Read these instructions.
- 2) Keep these instructions.
- 3) Heed all warnings.
- 4) Follow all instructions.
- 5) Do not use this apparatus near water.
- 6) Clean only with dry cloth.
- 7) Do not block any ventilation openings. Install in accordance with the manufacturer's instructions.
- 8) Do not install near any heat sources such as radiators, heat registers, stoves, or other apparatus (including amplifiers) that produce heat.
- 9) Do not defeat the safety purpose of the polarized or grounding-type plug. A polarized plug has two blades with one wider than the other. A grounding type plug has two blades and a third grounding prong. The wide blade or the third prong are provided for your safety. If the provided plug does not fit into your outlet, consult an electrician for replacement of the obsolete outlet.
- 10) Protect the power cord from being walked on or pinched particularly at plugs, convenience receptacles, and the point where they exit from the apparatus.
- 11) Only use attachments/accessories specified by the manufacturer.
- 12) Use only with the cart, stand, tripod, bracket, or the table specified by the manufacturer, or sold with the apparatus. When a cart is used, use caution when moving the cart/apparatus combination to avoid injury from tip-over.
- 13) Unplug this apparatus during lightning storms or when it will be left unused for long periods of time.
- 14) Refer all servicing to qualified service personnel. Servicing is required when the apparatus has been damaged in any way, such as when the power-supply cord or plug is damaged, liquid has been spilled or objects have fallen into the apparatus, the apparatus has been exposed to rain or moisture, does not operate normally, or has been dropped.



Precautions

USE & LOCATION

WARNING

- **TO AVOID SHOCK HAZARD ...** Your Camcorder and power supply should not be exposed to rain or moisture. Do not connect the power supply or operate your Camcorder if it gets wet. Your Camcorder has been designed for outdoor use, however it is not designed to sustain direct exposure to water, rain, sleet, snow, sand, dust, or a direct splashing from a pool or even a cup of coffee. This action could permanently damage the internal parts of your Camcorder. Do not attempt to disassemble this unit. There are no user serviceable parts inside. Unplug your Camcorder from the power supply before cleaning.

CAUTION

- **DO NOT AIM YOUR CAMCORDER AT THE SUN OR OTHER BRIGHT OBJECTS**
- **DO NOT LEAVE THE CAMCORDER WITH THE EVF AIMED DIRECTLY AT THE SUN AS THIS MAY CAUSE DAMAGE TO THE INTERNAL PARTS OF THE EVF**
- **DO NOT EXPOSE YOUR CAMCORDER TO EXTENDED HIGH TEMPERATURE ...** Such as, in direct sunlight, inside a closed car, next to a heater, etc... This action could permanently damage the internal parts of your Camcorder.

- **AVOID SUDDEN CHANGES IN TEMPERATURE ...** If the unit is suddenly moved from a cold place to a warm place, moisture may form on the tape and inside the unit.
- **DO NOT LEAVE YOUR CAMCORDER OR THE POWER SUPPLY TURNED ON WHEN NOT IN USE.**
- **STORAGE OF YOUR CAMCORDER ...** Store and handle your Camcorder in a manner that will not subject it to unnecessary movement (avoid shaking and striking). Your Camcorder contains a sensitive pick-up device which could be damaged by improper handling or storage.

CARE

- **TO CLEAN YOUR CAMCORDER ...** Do not use strong or abrasive detergents when cleaning your Camcorder body.
- **TO PROTECT THE LENS ...** Do not touch the surface of the lens with your hand. Use a commercial Camcorder lens solution and lens paper when cleaning the lens. Improper cleaning can scratch the lens coating.
- **TO PROTECT THE FINISH OF YOUR CAMCORDER ...** Before handling your Camcorder, make sure your hands and face are free from any chemical products, such as suntan lotion, as it may damage the finish.

Apparatus Claims of U.S. Patent Nos. 4,631,603, 4,577,216, and 4,819,098, licensed for limited viewing.

This product incorporates copyright protection technology that is protected by method claims of certain U.S. patents and other intellectual property rights owned by Macrovision Corporation and other rights owners. Use of this copyright protection technology must be authorized by Macrovision Corporation, and is intended for home and other limited viewing uses only unless otherwise authorized by Macrovision Corporation. Reverse engineering or disassembly is prohibited.

This class B digital apparatus complies with CANADIAN ICES-003.

U.S.A./CANADA CONSUMERS: ATTENTION:



A lithium ion/polymer battery that is recyclable powers the product you have purchased. Please call 1-800-8-BATTERY for information on how to recycle this battery.

Contents

Before using	Record mode
Quick Guide.....	Check before recording.....
Accessories.....	Recording on a tape.....
Parts identification and handling.....	Recording still pictures on a card while recording image onto a tape.....
Fitting the lens cap.....	Check the recording.....
The one-touch free-style grip belt.....	Blank search function.....
Using the LCD monitor.....	Recording still pictures onto a card (Photoshot).....
Using the viewfinder.....	Zoom in/out function.....
Power supply.....	Recording yourself.....
Charging time and recordable time.....	Quick start.....
Inserting/removing a cassette.....	Backlight compensation function.....
Inserting/removing a card.....	MagicPix functions.....
Turning the Camcorder on.....	Soft skin mode.....
Selecting a mode.....	Tele-macro function.....
How to use the joystick.....	Fade in/fade out function.....
Switching the language.....	Wind noise reduction function.....
Using the menu screen.....	Self-timer recording.....
Setting date and time.....	Recording images for wide-screen TVs.....
Adjusting LCD monitor/viewfinder.....	Image stabilizer function.....
Using the remote control.....	RapidFire Consecutive Photoshot.....
	Recording in various situations (Scene mode).....
	Recording in natural colors (White balance).....
	Manual focus adjustment.....
	Manual shutter speed/aperture adjustment.....

Playback mode	
Playing back tape	37
Slow-motion playback/ frame-by-frame playback	37
Variable-speed search function	38
Playback on TV	39
Playing back card	39
Deleting files recorded on a card	40
Formatting a card	41
Protecting files on a card	41
Writing the printing data on a card (DPOF setting)	41

Edit mode	
Recording from a tape onto a card	42
Copying onto a DVD recorder or a VCR (Dubbing)	42
Using the DV cable for Recording (Digital Dubbing)	43
Audio dubbing	44
Printing pictures by directly connecting to the printer (PictBridge)	45
Connecting Computer and Camcorder	46
Installing the USB Driver	46
To disconnect USB Cable safely	47

Menu	
Menu list	49
Menus related to taking pictures	51
Menus related to playback	51
Other menus	52

Others	
Indications	53
Warning/alarm indications	54
Functions cannot be used simultaneously	55
Before requesting repair (Problems and solutions)	56
Cautions for Use	59
Explanation of terms	63
Specifications	65
Camcorder Accessory System	67
Camcorder Accessory Order Form (For USA Customers)	68
Request for Service Notice (USA Only)	69
Limited Warranty (For USA Customers)	70
Customer Services Directory	71
Warranty (For Canadian Customers)	72
Index	73
Spanish Quick Use Guide/ Guía española para el uso rápido	74

Quick Guide

■ Charging the battery

- 1 Connect the AC main lead to the AC adaptor and the AC main socket.
- 2 Put the battery on the battery mount by aligning the mark, and then securely plug it in.

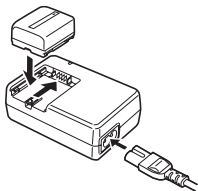

■ Fitting the battery

Push the battery against the battery holder and slide it until it clicks.

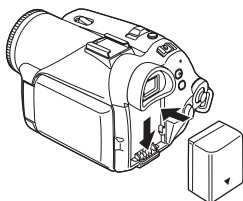

■ Inserting/removing a cassette

- 1 Slide the [OPEN/EJECT] lever and open the cassette cover.

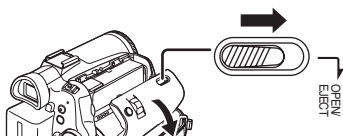

- 2 After the cassette holder is opened, insert/remove the cassette.

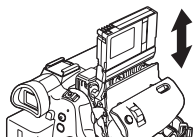

- 3 Push the [PUSH] mark ❶ in order to close the cassette holder.

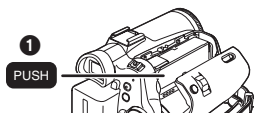

- 4 Only after the cassette holder is completely housed, close the cassette cover.

■ Inserting/removing a card

- 1 Open the LCD monitor and then open the card slot cover.



- 2 Insert/remove the card into/from the card slot.

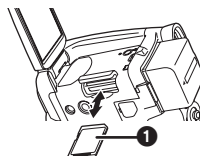

- When inserting a card, face the label side ❶ towards you and push it straight in with one stroke as far as it goes.
- When removing the card, open the card slot cover and press the center of the card and then pull it straight out.

- 3 Securely close the card slot cover.

■ How to turn on the power

- 1 While pressing the button ❶, set the [OFF/ON] switch to [ON].

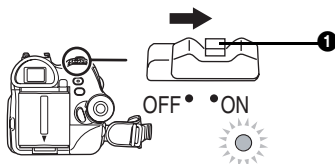

How to turn off the power

- 1 While pressing the button ①, set the [OFF/ON] switch to [OFF].

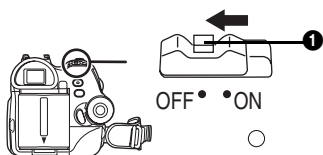

Recording on a tape

- Set to Tape Recording Mode.

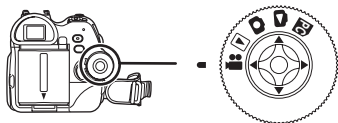

- 1 Press the recording start/stop button to start recording.



- 2 Press the recording start/stop button again to pause recording.



Recording still pictures onto a card (Photoshot)

- Set to Card Recording Mode.

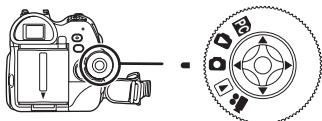

- 1 Press the [PHOTO SHOT] button.



Playing back tape

- Set to Tape Playback Mode.

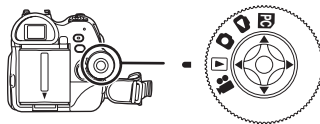

- 1 Operate with joystick.



- ▶/||: Playback/Pause
- ◀◀: Rewind/Review playback (Reverts to playback with the ▶/|| icon.)
- ▶▶: Fast forward/Cue playback (Reverts to playback with the ▶/|| icon.)
- : Stop

Playing back card

- Set to Picture Playback Mode.

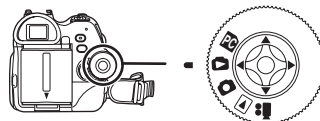

- 1 Operate with joystick.



- ◀◀: Plays back the previous picture.
- ▶▶: Plays back the next picture.
- ▶/■: Slide show (Plays back the still pictures on the card in order) start/stop

Before using

Accessories

The following are the accessories supplied with this product.

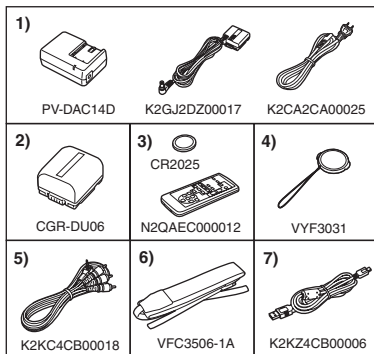

1) AC adaptor, DC cable, AC cable -14-

CAUTION:

This unit will operate on 110/120/220/240 V AC. An AC plug adaptor may be required for voltages other than 120 V AC. Please contact either a local or foreign electrical parts distributor for assistance in selecting an alternate AC plug. We recommend using the accessory power plug adaptor (VJSS0070) in an area which has special AC outlets.

- 2) Battery pack -14-
- 3) Remote control, button-type battery -22-
- 4) Lens cap -12-
- 5) AV cable -42-
- 6) Shoulder strap -12-
- 7) USB cable -45-

Parts identification and handling

Camcorder

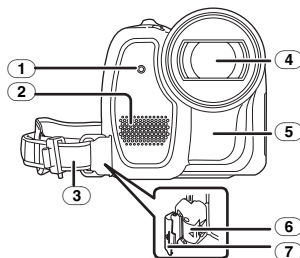

- ① Recording lamp -51-
- ② Microphone (built-in, stereo) -28-, -31-
- ③ Grip belt (One-touch free style grip belt) -12-
- ④ Lens
- ⑤ White balance sensor -35-
Remote control sensor -23-
- ⑥ Lock button -12-
- ⑦ Lock cover -12-

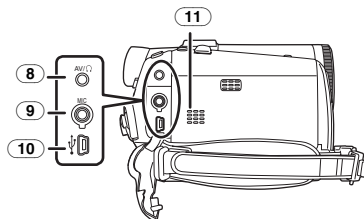

- ⑧ Audio-video output terminal [AV] -42-
 - Use the supplied AV cable or headphones only, otherwise audio may not be played back normally.
- Headphone terminal []
- ⑨ Microphone terminal [MIC]
 - A compatible plug-in powered microphone can be used as an external microphone.
 - When the Camcorder is connected with AC Adaptor, sometimes noise may be heard depending on microphone type. In that case, please switch to battery for power supply and noise will stop.
- ⑩ USB terminal [] -45-
- ⑪ Speaker -37-

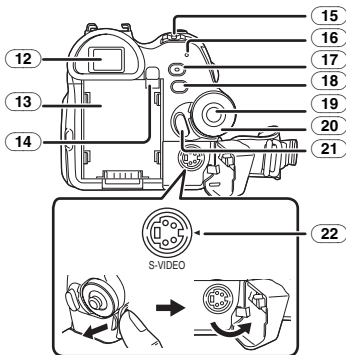

12 Viewfinder -13-, -63-

Due to limitations in LCD production technology, there may be some tiny bright or dark spots on the viewfinder screen. However, this is not a malfunction and does not affect the recorded picture.

- 13 Battery holder
- 14 Battery eject button [PUSH BATT] -14-
- 15 Power switch [OFF/ON] -17-
- 16 Power lamp -17-
- 17 Quick start recording button [QUICK START] -29-
- Quick start recording lamp -29-
- 18 Menu button [MENU] -19-
- 19 Joystick -18-
- 20 Mode dial -17-
- 21 Recording start/stop button -25-
- 22 S-Video output terminal [S-VIDEO] -39-

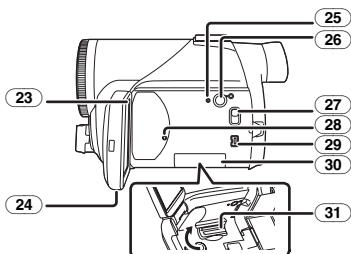

23 LCD monitor -13-, -63-

Due to limitations in LCD production technology, there may be some tiny bright or dark spots on the LCD monitor screen. However, this is not a malfunction and does not affect the recorded picture.

- 24 LCD monitor open knob [OPEN▼] -13-
- 25 Reset button [RESET] -54-

- 26 Power LCD button [POWER LCD] -21-
- Power LCD lamp -21-
- 27 Mode select switch [AUTO/MANUAL/FOCUS] -24-, -33-, -36-
- 28 Card access lamp -17-
- 29 DV terminal [DV] -43-
- 30 Card slot cover -16-
- 31 Card slot -16-

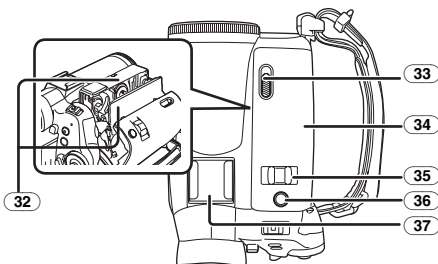

- 32 Cassette holder -15-
- 33 Cassette eject lever [OPEN/EJECT] -15-
- 34 Cassette cover -15-
- 35 Zoom lever [W/T] -27-
- Volume lever [-□/VOL+] -37-
- 36 Photoshot button [PHOTO SHOT] -26-
- 37 Accessory shoe

●Accessories, such as a stereo microphone, are attached here.

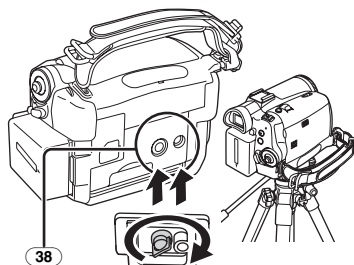

38 Tripod receptacle

This is a hole for attaching the Camcorder to optional tripod. (Please carefully read the operating instructions for how to attach the tripod to the Camcorder.)

●You cannot open the card slot cover when the tripod is used. Insert the card first and then attach the tripod.

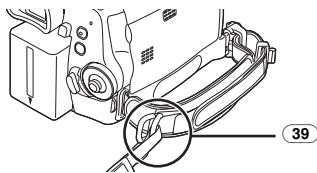

39) Shoulder strap fixture

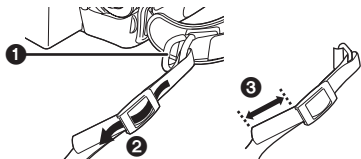

- Put the strap through the fixture **1** and through the stopper **2** so it will not come off. Extend part **3** by at least 1 inch (2 cm).
- Fit the other end of the belt similarly.

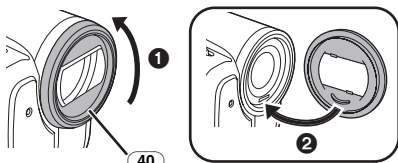

40) Lens hood

In order to remove the lens hood, rotate it counter-clockwise **1**. In order to fit it, put into slot **2**, and then rotate it clockwise.

Fitting the lens cap

Fit the lens cap to protect the surface of the lens.

- 1 Remove the grip belt. Run the end of the lens cap cord through the hole in the grip belt attachment and run the lens cap through the lens cap cord.**

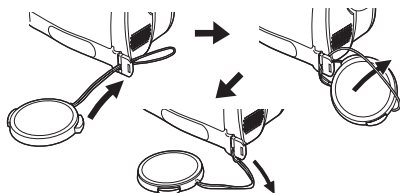

- The lens cap removed can be attached to the lens cap fixture. (It cannot be hung if the grip belt is used as a hand strap.)

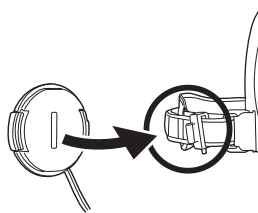

- To fit or remove the lens cap, hold both sides of the lens cap with the tips of your finger and thumb.

The one-touch free-style grip belt

■ To use as a hand strap

If you use the grip belt as a hand strap, then you can carry or handle this Camcorder more easily.

- 1 Open the lock cover 1 by pinching the projections 2 on both sides. Press the lock button 3 to remove the grip belt.**

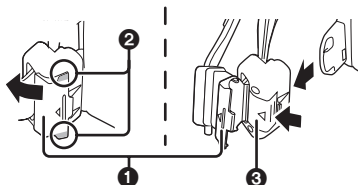

- When removing the grip belt, tightly hold the Camcorder with both hands.
- After removing the grip belt, restore the lock cover to the original position.

- 2 Adjust the belt length.**

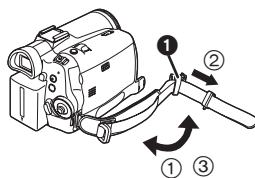

- ① Flip the belt.
- ② Slide **1** in the direction indicated by the arrow.
- ③ Fix the belt.

- 3 Put your hand through the strap.**

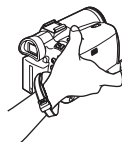

- Hold the Camcorder not to cover the microphones or the sensors with your hands.

■ To restore the strap to the grip belt

- When returning the grip belt to the grip belt attachment, press the lock cover **1** and check if the grip belt is securely locked.

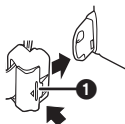

■ To use as a grip belt

Adjust the belt length so it fits your hand.

1 Adjust the belt length and the pad position.

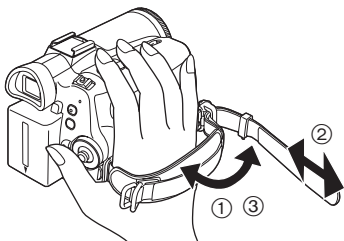

- 1 Flip the belt.
- 2 Adjust the length.
- 3 Fix the belt.

Using the LCD monitor

You can record the image while viewing it on the LCD monitor.

1 Put a finger on the [OPEN▼] knob and pull the LCD monitor out in the direction of the arrow.

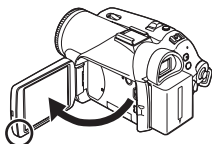

- The viewfinder is now deactivated.
- It can open up to 90°.

2 Adjust the angle of the LCD monitor according to your preference.

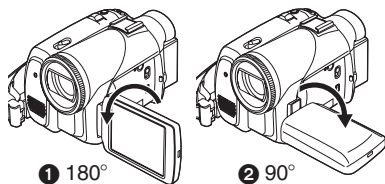

- It can rotate up to 180° **1** towards the lens or 90° **2** towards the viewfinder.

- The brightness and color level of the LCD monitor can be adjusted from the menu.
- If it is forcibly opened or rotated, the Camcorder may be damaged or fail.
- Check that the card slot cover is closed.
- When the LCD monitor is rotated by 180° towards the lens (when recording yourself), the LCD monitor and the viewfinder will be simultaneously activated.

Using the viewfinder

■ Extending the viewfinder

1 Pull out the viewfinder and extend it by pulling the extension knob.

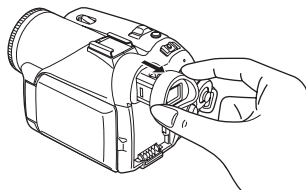

■ Adjusting the field of view

1 Adjust the focus by sliding the eyepiece corrector knob.



- You can adjust the brightness of the viewfinder from the menu.

Power supply

Charging the battery

When this product is purchased, the battery is not charged. Charge the battery before using this product.

- Battery charging time (-15-)
- We recommend using Panasonic batteries.
- If you use other batteries, we cannot guarantee the quality of this product.
- If the DC input lead is connected to the AC adaptor, then the battery will not charge.

Remove the DC input lead from the AC adaptor.

1 Connect the AC cable to the AC adaptor and the AC jack.

2 Put the battery on the battery mount by aligning the mark, and then securely plug it in.

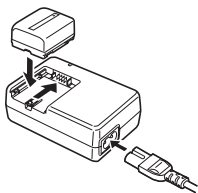

Charging lamp

Lights up: Charging

Goes off: Charging completed

Flashing: The battery is over discharged (discharged excessively). In a while, the lamp will light up and normal charging will start.

When the battery temperature is excessively high or low, the [CHARGE] lamp flashes and the charging time will be longer than normal.

Connecting to the AC outlet

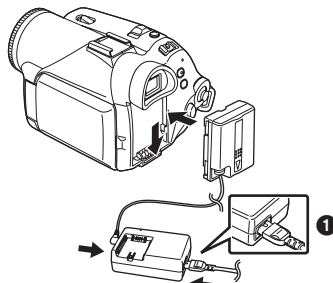

1 Connect the AC cable to the AC adaptor and the AC jack.

2 Connect the DC cable to the AC adaptor.

3 Connect the DC cable to this product.

- The output plug of the AC cable is not completely connected to the AC adaptor jack. As shown in ❶, there is a gap.
- Do not use the power cord for other equipment since the power cord is exclusively designed for this Camcorder. Do not use the power cord from other equipment for this Camcorder.

Fitting the battery

Push the battery against the battery holder and slide it until it clicks.

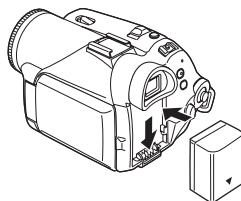

Removing the battery

While pushing the [PUSH BATT] button, slide the battery (or the DC input lead) to remove it.

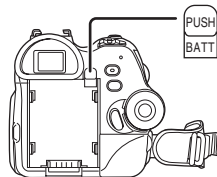

- Hold the battery with your hand so it does not fall.

Charging time and recordable time

The times shown in the table below show the times at a temperature of 68°F (25°C) and a humidity of 60%. This is just a guide. If the temperature is higher or lower than the specified value, the charging time will become longer.







Supplied battery/ CGR-DU06 (7.2 V/ 640 mAh)	(A)	1 h. 40 min.
	(B)	1 h. 25 min. (1 h. 20 min.)
CGA-DU12 (7.2 V/ 1150 mAh)	(A)	2 h. 25 min.
	(B)	2 h. 40 min. (2 h. 25 min.)
CGA-DU21 (7.2 V/ 2040 mAh)	(A)	3 h. 55 min.
	(B)	4 h. 30 min. (4 h. 15 min.)

(A) Charging time

(B) Maximum continuously recordable time

“1h. 10 min.” indicates 1 hour 10 minutes.

- The battery CGR-DU06 is supplied.
- The times shown in the table are rough estimates. The times indicate the recordable time when the viewfinder is used. The times in parentheses indicate the recordable time when the LCD monitor is used.
- We recommend the Battery Pack CGA-DU12 and CGA-DU21 for long recording time (2 hour or more for continuous recording, 1 hour or more for intermittent recording).

- The recordable time will become shorter in the following cases:
 - When you use both the viewfinder and the LCD monitor simultaneously while rotating the LCD monitor frontward to record yourself, 0 Lux MagicPix function, etc.
 - When you use this Camcorder with the LCD monitor lit up by pressing the [POWER LCD] button.
- The batteries heat up after use or charging. The Camcorder being used will also heat up. This is normal.
- Along with the reduction of the battery capacity, the display will change:  →  →  →  → . If the battery discharges, then  () will flash.

Inserting/removing a cassette

- 1 Slide the [OPEN/EJECT] lever and open the cassette cover.

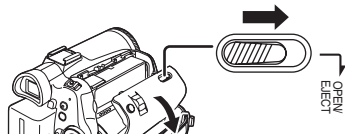

- When the cover is fully opened, the cassette holder will come out.
- 2 After the cassette holder is opened, insert/remove the cassette.

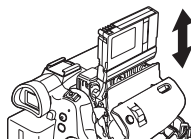

- When inserting a cassette, orient it as shown in the figure, and then securely insert it as far as it goes.
 - When removing, pull it straight out.
- 3 Push the [PUSH] mark ① in order to close the cassette holder.

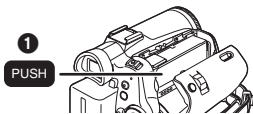

- 4 Only after the cassette holder is completely housed, close the cassette cover.

- After using, make sure to rewind the cassette completely, remove it, and put it in a case. Store the case in an upright position. (-62-)
- When condensation is formed on the lens or the main unit of the Camcorder, even if no condensation alarm is indicated, condensation may have formed on the heads or the cassette tape. Do not open the cassette cover. (-59-)

■ When the cassette holder does not come out

- Close the cassette cover completely, and then open it again completely.
- Check if the battery has run down.

■ When the cassette holder cannot be housed

- Set the [OFF/ON] switch to [OFF], then to [ON] again.
- Check if the battery has run down.

■ Inserting/removing the cassette

- When the cassette holder is in motion, do not touch anything except the [PUSH] mark.
- When inserting a previously recorded cassette, use the blank search function to find the position where you want to continue recording. If you overwrite-record on a previously recorded cassette, be sure to find the position where you want to continue recording.
- Close the cassette cover tightly.
- When closing the cassette cover, do not get anything, such as a cable, caught in the cover.

■ Accidental erasure prevention

If the accidental erasure prevention slider ❶ of a cassette is opened (slide in the direction of the [SAVE] arrow), the cassette cannot be recorded. When recording, close the accidental erasure prevention slider of the cassette (slide in the direction of the [REC] arrow).

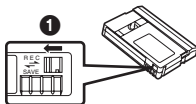

Inserting/removing a card

Before inserting/removing a card, be sure to turn the power [OFF].

- If the card is inserted or removed with the power turned on, this Camcorder may malfunction or the data recorded on the card may be lost.

1 Open the LCD monitor and then open the card slot cover.



2 Insert/remove the card into/from the card slot.

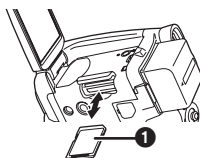

- When inserting a card, face the label side ❶ towards you and push it straight in with one stroke as far as it goes.
- When removing the card, open the card slot cover and press the center of the card and then pull it straight out.

3 Securely close the card slot cover.

■ Concerning the card

- Do not touch the terminals on the back of the card.
- Do not format the card with another Camcorder or any personal computer. This operation may make the card unusable.
- Electrical noise, static electricity, or failure of the Camcorder or the card may damage or erase the data stored on the card. We recommend saving important data on a personal computer by using a USB cable, PC card adaptor, or USB reader/writer.

■ Card access lamp

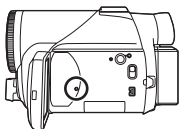

- When the Camcorder accesses the card (reading, recording, playback, erasing, etc.), the access lamp lights up.
- If the following operations are performed when the access lamp is lit, then the card or the recorded data may be damaged or the Camcorder may malfunction.
 - Opening the card slot cover and inserting or removing the card
 - Operating the [OFF/ON] switch or the mode dial

■ SD Memory Card

- The memory capacity indicated on the SD Memory Card label corresponds to the total amount of capacity to protect and manage the copyright and the capacity available as conventional memory for a Camcorder, personal computer or other equipment.

■ Concerning the write protection switch on the SD Memory Card

- The SD Memory Card has a write protection switch on it. If the switch is moved to [LOCK], you cannot write to the card, erase the data on it, or format it. If it is moved back, you can perform those functions.

Turning the Camcorder on

When the Camcorder is turned on with the lens cap fitted, the automatic white balance adjustment may not function properly. Please turn the Camcorder on after removing the lens cap.

■ How to turn on the power

1 While pressing the button ①, set the [OFF/ON] switch to [ON].

- The power lamp lights up.

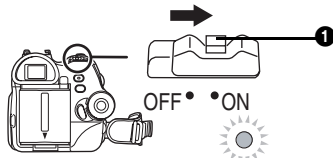

■ How to turn off the power

1 While pressing the button ①, set the [OFF/ON] switch to [OFF].

- The power lamp goes off.

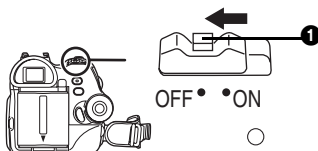

Selecting a mode

Rotate the mode dial to select the desired mode.

1 Rotate the mode dial.

- Set your desired mode to ①.

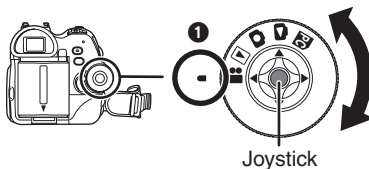

📹 : Tape recording mode

Use this when you want to record the image on a tape. (Also, you can simultaneously record still pictures on a card while recording images on a tape.)

▶ : Tape playback mode

Use this to play back a tape.

📷 : Card recording mode

Use this to record still pictures on a card.

▶ : Picture playback mode

Use this to play back the still pictures recorded on a card.

PC : PC mode

You can view or edit the images recorded on a card on your personal computer.

How to use the joystick

Basic joystick operations

Operations on the menu screen and selection of files to be played back on the multi-image display

Move the joystick up, down, left, or right to select an item or file, and then push in the center to set it.

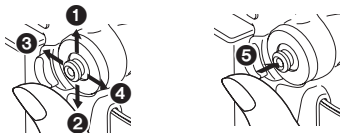

1	Select by moving up.
2	Select by moving down.
3	Select by moving left.
4	Select by moving right.
5	Push the center to select the item.

Joystick and screen display

Push the center of the joystick, and icons will be displayed on the screen. Each push switches the display as follows depending on the mode. (In the Tape playback mode or the Picture playback mode, the icons will be automatically displayed on the screen.)

1) Tape recording mode ([AUTO/MANUAL/FOCUS] switch is set to [AUTO])



▲	☺	Tele-macro	-31-
▼	☺	Soft skin mode	-30-
◀	☺	Fade	-31-
▶	☺	Backlight compensation	-29-
▲	★	MagicPix/0 Lux MagicPix	-30-
▼	📺	Recording check	-26-

2) Tape recording mode ([AUTO/MANUAL/FOCUS] switch is set to [MANUAL])



▼	▼	White balance	-34-
		Shutter speed	
		Iris or gain value	
▶	+	Select/Adjust	-34-
◀	-	Select/Adjust	-34-

3) Tape playback mode

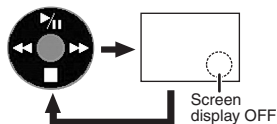

▲	▶	Playback/pause	-37-
▼	■	Stop	-37-
◀	◀◀	Rewind (review playback)	-37-
▶	▶▶	Fast forward (cue playback)	-37-

4) Card recording mode ([AUTO/MANUAL/FOCUS] switch is set to [AUTO])

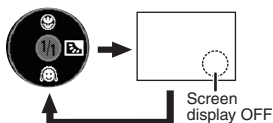

▲	☺	Tele-macro	-31-
▼	☺	Soft skin mode	-30-
▶	☺	Backlight compensation	-29-

5) Card recording mode
 ([AUTO/MANUAL/FOCUS] switch is set to [MANUAL])

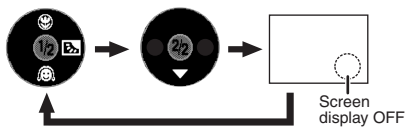

▼	▼	White balance Shutter speed Iris or gain value	-34-
▶	+	Select/Adjust	-34-
▶	-	Select/Adjust	-34-

6) Picture playback mode

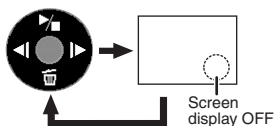

▲	▶/■	Playback/stop	-39-
▼	🗑️	Erase	-40-
◀	◀	Playback previous picture	-39-
▶	▶	Playback next picture	-39-

Switching the language

You can switch the language on the screen display or the menu screen.

1 Set [LANGUAGE] >> [English].



Using the menu screen

For each individual menu, please refer to -49-.

1 Press the [MENU] button.

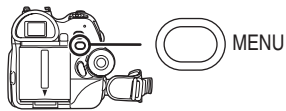

- The menu corresponding to the mode selected by the mode dial is displayed.
- Do not switch the mode dial when the menu is displayed.

2 Move the joystick up or down in order to select the top menu.



3 Move the joystick right or press it to set the selection.



4 Move the joystick up or down in order to select the sub-menu.

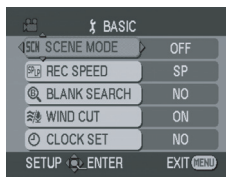

5 Move the joystick right or press it to set the selection.



6 Move the joystick up or down in order to select the item to be set.



7 Press the joystick to determine the setting.



To exit the menu screen

Press the [MENU] button.

To get back to the previous screen

Move the joystick left.



About the menu setting

- The menu screen does not appear during recording. And you cannot record when the menu screen appears.

Operating with remote control

The menu screen transition is the same as when the buttons on the main unit are used.

1 Press the [MENU] button.



2 Select a menu item.

- Use the direction buttons (▲, ◀, ▶, ▼) and [ENTER] button in place of the joystick on the main unit.

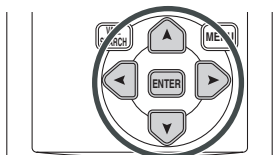

3 Press the [MENU] button, to exit the menu screen.

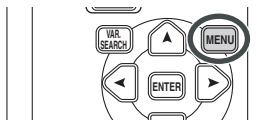

Setting date and time

If the screen shows the incorrect date/time, then adjust it.

Set to Tape Recording Mode or Card Recording Mode.

1 Set [BASIC] >> [CLOCK SET] >> [YES].



2 Move the joystick left or right in order to select the item to be set. Then move the joystick up or down to set the desired value.

- The year will change as follows: 2000, 2001, ..., 2089, 2000, ...
- The 12-hour clock is used.

3 Press the joystick to determine the setting.

- The clock function starts at [00] seconds.

About date/time

- The date and time function are driven by a built-in lithium battery.
- Make sure to check the time before recording because the built-in clock is not very accurate.

Recharging the built-in lithium battery

- If [⊖] or [--] is indicated when the Camcorder is turned on, then the built-in lithium battery has run down. Connect the AC adaptor to the Camcorder or place the battery on the Camcorder, and the built-in lithium battery will be recharged. Leave the Camcorder as is for approx. 24 hours, and the battery will drive the date and time for approx. 6 months. (Even if the [OFF/ON] switch is set to [OFF], the battery is still being recharged.)

Adjusting LCD monitor/viewfinder

Adjusting the brightness and color level

1 Set [SETUP] >> [LCD SET] or [EVF SET] >> [YES].

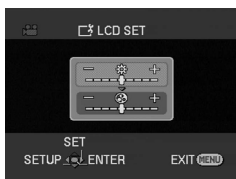

2 Move the joystick up or down in order to select the item to be adjusted.

[LCD SET]

☀ : Brightness of the LCD monitor

🎨 : Color level of the LCD monitor

[EVF SET]

EVF☀ : Brightness of the viewfinder

3 Move the joystick left or right to move the bar indication representing the brightness.

4 Press the [MENU] button or the joystick to complete the settings.

- In order to adjust the brightness of the viewfinder, close the LCD monitor, and the viewfinder will be activated.
- When the LCD monitor is rotated by 180° towards the lens, the brightness of the LCD monitor cannot be adjusted.
- These settings will not affect the images actually recorded.

In order to increase the brightness of the entire LCD monitor

1 Press the [POWER LCD] button.

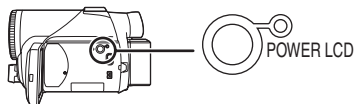

- The [POWER LCD] lamp lights up.
 - If the [POWER LCD] button is pressed, the entire LCD monitor will become approx. twice as bright as the normal.
-
- Press this button again, and the lamp will go off and the brightness will revert back to the original brightness.
 - This will not affect the images to be recorded.
 - If you turn on the Camcorder when the AC adaptor is used, the [POWER LCD] function will automatically be activated.

Using the remote control

Remote control

Using the remote control supplied will enable control of almost all functions of this Camcorder.

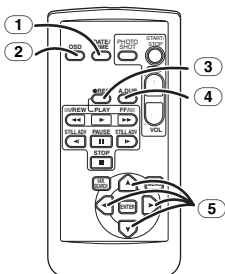

- ① Date/time button [DATE/TIME] -49-
- ② On-screen display button [OSD] -39-
- ③ Record button [●REC] -43-
- ④ Audio dubbing button [A.DUB] -44-
- ⑤ Direction buttons [▲, ◀, ▶, ▼] -20-

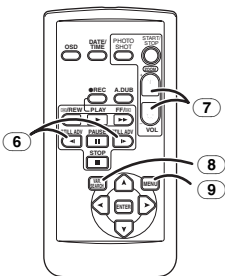

- ⑥ Slow/frame-by-frame forward button [◀, ▶] (◀: reverse, ▶: forward) -37-
- ⑦ Zoom/volume button [ZOOM/VOL] *
- ⑧ Search button [VAR. SEARCH] -38-
- ⑨ Menu button [MENU] -20-

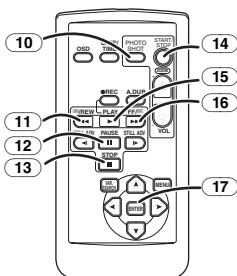

- ⑩ Photoshot button [PHOTO SHOT] *
- ⑪ Rewind/review button [◀◀]
- ⑫ Pause button [||]
- ⑬ Stop button [■]

- ⑭ Recording start/stop button [START/STOP] *
- ⑮ Playback button [▶]
- ⑯ Fast forward/cue button [▶▶]
- ⑰ Enter button [ENTER] -20-

* means that these buttons function in the same manner as the corresponding buttons on the Camcorder.

Install a button-type battery

Install the button-type battery supplied in the remote control before using it.

- 1 While pressing the stopper ①, pull out the battery holder.

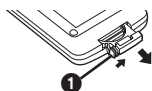

- 2 Set the button-type battery with its (+) mark facing upward and slide the battery holder back into place.

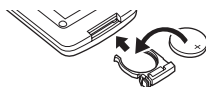

Warning

Danger of explosion if battery is incorrectly replaced.

Replace only with the same or equivalent type recommended by the equipment manufacturer. Discard used batteries according to manufacturer's instructions. Risk of fire, explosion and burns. Do not recharge, disassemble, heat above 212°F (100°C) or incinerate. Keep the Button-Type battery out of the reach of children. Never put Button-Type battery in mouth. If swallowed, call your doctor.

Replace battery with Panasonic PART NO. CR2025 only. Use of another battery may present a risk of fire or explosion. Caution: Battery may explode if mistreated. Dispose of used battery promptly. Keep away from children. Do not recharge, disassemble or dispose of in fire.

Remote control usable range

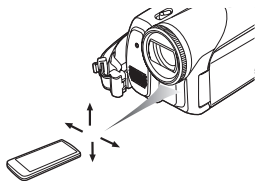

- The distance between the remote control and the Camcorder: Within approx. 15 feet (5 m)
Angle: Approx. 10° up and 15° down, left, and right

Selecting the remote control mode

If 2 Camcorders are used simultaneously, set the mode for one pair of Camcorder and remote control to [VCR1] and that of the other pair to [VCR2]. This will prevent interference between the 2 pairs. (The default setting is [VCR1]. When the button-type battery is replaced, the setting will revert to the default [VCR1].)

1 Setting on the Camcorder:

Set [SETUP] >> [REMOTE] >> [VCR1] or [VCR2].

2 Setting on the remote control:

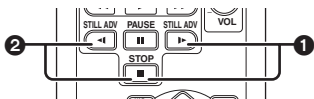

[VCR1]:

Press [▶] and [■] simultaneously. ①

[VCR2]:

Press [◀] and [■] simultaneously. ②

Concerning the button-type battery

- When the button-type battery runs down, replace it with a new battery (part number: CR2025). The battery is normally expected to last about 1 year, but it depends on operation frequency.
 - Keep the button-type battery out of the reach of children.
-
- If the remote control mode of the Camcorder and that of the remote control do not match with each other, "REMOTE" will appear. When the remote control is operated for the first time after the Camcorder is turned on, "CHECK REMOTE MODE" (-54-) will appear and operation is impossible. Set the same remote control mode.
 - The remote control is intended for indoor operation. Outdoors or under strong light, the Camcorder may not operate properly even within the usable ranges.
 - Within a 3 feet (1 m) range, you can operate the remote control using the remote control sensor on the LCD monitor side of the Camcorder.

Record mode

Check before recording

Check the following by a trial recording before important events such as weddings in order to verify that the image recording and audio recording work properly and that you know how to use the Camcorder.

Basic Camcorder holding

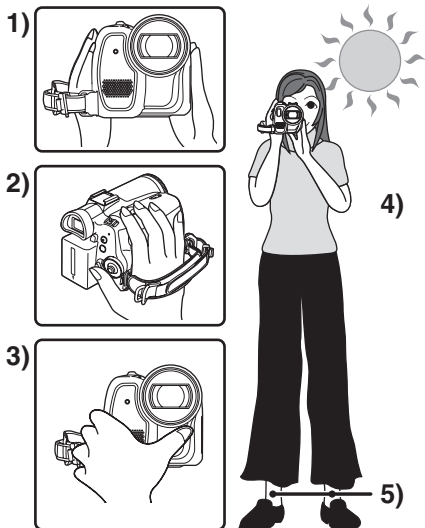

- 1) Hold the Camcorder with both hands.
 - 2) Run your hand through the grip belt.
 - 3) Do not cover the microphones or sensors with your hands.
 - 4) Keep your arms near your body.
 - 5) Slightly open your legs.
- When you are in the open air, record pictures with the sunlight as far in the background as possible. If the subject is backlit, it will become dark in the recording.

Check points

- Remove the lens cap. (-12-)
(When the Camcorder is turned on with the lens cap fitted, the automatic white balance adjustment may not function properly. Please turn the Camcorder on after removing the lens cap.)
- Grip belt adjustment (-12-)
- Power supply (-14-)
- Insert a cassette/card. (-15-, -16-)
- Setting date/time (-20-)
- Adjustment of LCD monitor/viewfinder (-21-)
- Getting the remote control ready (-22-)
- Setting SP/LP mode (-24-)

About auto mode

- Set the [AUTO/MANUAL/FOCUS] switch to [AUTO], and color balance (white balance) and focusing will be adjusted automatically.
 - Auto white balance: -64-
 - Auto focusing: -64-
- Color balance and focus may not be adjusted depending on light sources or scenes. If so, manually adjust the white balance and focus.



- Scene mode setting (-33-)
- White balance setting (-34-)
- Shutter speed setting (-36-)
- Iris/gain value setting (-36-)
- Focus setting (-35-)

Recording mode

You can switch the tape recording mode.

- Set to Tape Recording/Playback Mode.

1 Set [BASIC] or [ADVANCE] >> [REC SPEED] >> [SP] or [LP].

If the LP mode is selected, the recording time will be 1.5 times the SP mode, but some functions will be disabled.

- We recommend using the SP mode for important recording.
- In order to fully exhibit the performances of the LP mode, we recommend using Panasonic cassettes marked LP mode.
- It is not possible to dub audio onto images recorded in the LP mode. (-44-)
- In the LP mode, the picture quality will not be degraded in comparison with the SP mode, but mosaic noise may appear on the playback image or some functions may be disabled.
 - Playback on other digital video equipment or on digital video equipment without the LP mode
 - Playback of the image on other digital video equipment recorded in the LP mode
 - Slow/frame-by-frame playback

Recording on a tape

- Remove the lens cap. (-12-)
(When the Camcorder is turned on with the lens cap fitted, the automatic white balance adjustment may not function properly. Please turn the Camcorder on after removing the lens cap.)
- **Set to Tape Recording Mode.**

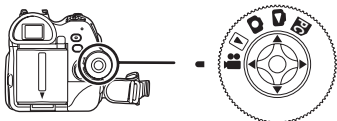

- 1 Press the recording start/stop button to start recording.**



- 2 Press the recording start/stop button again to pause recording.**



- For details on the recording time on a tape, refer to -15-.
- Carry out a recording check (-26-) to verify that the image is recorded properly.
- In order to find the unrecorded section, carry out the blank search (-26-).

On-screen display in the tape recording mode

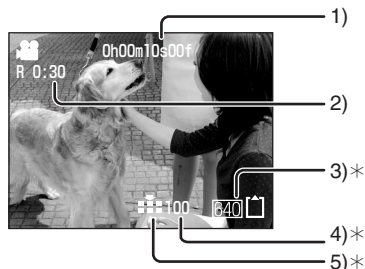

*These indications are displayed only when the card is inserted.

- 1) Recording time elapsed
- 2) Remaining tape indication
- 3) Still picture size
- 4) Number of recordable still pictures
(When no picture can be recorded, this indication will flash in red.)
- 5) Quality of still pictures

Concerning the remaining tape time indication on the screen

- The remaining tape time is indicated in minutes.
(When it reaches less than 3 minutes, the indication starts flashing.)
- During a 15-second or shorter recording, the remaining tape time indication may not be displayed or the remaining tape time may not be displayed correctly.
- In some cases, the remaining tape time indication may display remaining tape time that is 2 to 3 minutes shorter than the actual remaining tape time.

[POWER SAVE]

[OFF]:

When 5 minutes passes without any operation, the standby mode will be automatically set. In the standby mode, [] blinks and it takes more time than usual to start recording after you press the recording start/stop button.

[5 MINUTES]:

When 5 minutes passes without any operation, the Camcorder automatically turns off to protect the tape or to prevent the battery from running down. When you want to use the Camcorder, turn it on again.

- The Camcorder cannot be automatically turned off when you connect the USB connection cable or the DV cable with the Camcorder or when the Camcorder is in the PC mode.

Recording still pictures on a card while recording image onto a tape

You can record still pictures while recording image onto a tape.

● Set to Tape Recording Mode.

- 1 Press the [PHOTO SHOT] button fully while recording image onto a tape.



- For the number of still pictures to be recorded on a card, refer to -66-.
- When recording pictures onto a card, the recording start/stop button is disabled.
- You can select a picture quality for still pictures to be recorded. (-27-)
- In tape recording mode, the size of pictures that can be recorded is [640].
- In order to record higher quality still pictures, you must use the card recording mode.

Check the recording

The last image recorded is played back for 2 to 3 seconds. After checking, the Camcorder will be set to a recording pause.

● Set to Tape Recording Mode.

- 1 Press the joystick during the recording pause until the icon ❶ appears.
- 2 Move the joystick down to select the recording check icon [📷].



Blank search function

Searches for the last part of the image recorded (unused part of the tape).

● Set to Tape Recording/Playback Mode.

- 1 Set [BASIC] or [ADVANCE] >> [BLANK SEARCH] >> [YES].

■ Stopping a blank search midway through

Move the joystick down.

- If the cassette tape has no blank part, then the Camcorder will stop at the end of the tape.
- The Camcorder stops at a point approx. 1 second before the end of the last image recorded. When you start recording at that point, the image can be recorded seamlessly from the last image.

Recording still pictures on a card (Photoshot)

● Set to Card Recording Mode.

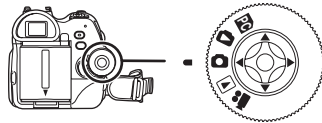

- 1 Press the [PHOTO SHOT] button.



■ To record still pictures clearly

- When zooming in on the subject with a magnification of 4× to 10× or higher, it is difficult to reduce the slight shaking from holding the Camcorder by hand. We recommend decreasing the zoom magnification and approaching the subject when recording.
- When recording still pictures, hold the Camcorder firmly with your hands and keep your arms stationary at your side so as not to shake the Camcorder.
- You can record stable pictures without shaking by using a tripod and the remote control.

- For the number of still pictures to be recorded on a card, refer to -66-.
- The sound cannot be recorded.
- While data is being recorded on a card, do not operate the mode dial.
- When the access lamp is lit, do not insert or remove a card.

- Another product may degrade or not play back data recorded on this Camcorder.
- If set [PICT. QUALITY] >> [], mosaic-pattern noise may appear on a playback image depending on the picture content.
- When the [PICTURE SIZE] is set to other than [640], the mega pixel recording mode is set.
- When the picture size setting is other than [640], the scene around the subject can be recorded wider than that in [640].

■ On-screen display in the card recording mode

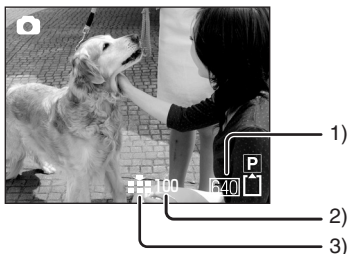

- 1) Still picture size
- 2) Number of recordable still pictures (When no pictures can be recorded, the red light will flash.)
- 3) Quality of still pictures

■ Progressive Photoshot

You can record still pictures with higher picture quality and frames. (You cannot switch the progressive function off/on.)



- In the tape recording mode, the progressive function may be disabled depending on the other functions used. (-55-)

■ Select the size of still pictures to be recorded on a card

1 Set [BASIC] >> [PICTURE SIZE] >> select the desired picture size.

[1280]: 1280×960

[640]: 640×480

■ Select the picture quality for photoshot images

1 Set [BASIC] >> [PICT. QUALITY] >> select a desired picture quality.

[]: High picture quality

[]: Normal picture quality

- You can also change the picture quality on [ADVANCE] >> [PICT. QUALITY] in the tape recording mode.

■ Recording with a shutter operation effect

You can add a shutter operation simulating sound.

1 Set [ADVANCE] >> [SHTR EFFECT] >> [ON].

Zoom in/out function

You can zoom in up to 10× optically.

- Set to Tape/Card Recording Mode.

1 Wide-angle recording (zoom out):

Push the [W/T] lever towards [W].

Close-up recording (zoom in):

Push the [W/T] lever towards [T].



- When zooming in and taking a picture while holding the Camcorder by hand, we recommend using the image stabilizer function.
- When you are zooming on a faraway subject, a sharper focus is achieved if the recording subject is 3.9 feet (1.2 m) or further from the Camcorder.
- When the zoom speed is high, the subject may not be focused easily.
- When the zoom magnification is 1×, the Camcorder can focus on a subject approx. 1.6 inches (4 cm) distant from the lens.

■ Digital zoom function

If the zoom magnification exceeds 10 times, then the digital zoom function will be activated. The digital zoom function allows you to select a magnification from 25× to 700×.

1 Set [ADVANCE] >> [D.ZOOM] >> [25×] or [700×].



[OFF]: Optical zoom only (Up to 10×)

[25×]: Up to 25×

[700×]: Up to 700×

- The larger the digital zoom magnification, the more the image quality is degraded.
- When the Card Recording mode is used, the digital zoom function cannot be used.

■ To use the zoom microphone function

Interlocked with the zooming operation, the microphone will clearly capture sounds far away with the tele-shot or those in the vicinity with the wide-angle shot.

● **Set to Tape Recording Mode.**

1 Set [ADVANCE] >> [ZOOM MIC] >> [ON].



■ About the variable speed zoom function

- When pushing the [W/T] lever as far as it will go, you can zoom from 1× to 10× in 2.1 second at the maximum.
- The zoom speed varies according to the amount of movement of the [W/T] lever.
- The variable speed zoom function cannot be used with the remote control.

Recording yourself

You can record yourself while viewing the LCD monitor. You can record persons in front of the Camcorder while showing them the image. The image is horizontally flipped as if you see a mirror image. (The image to be recorded is the same as that recording.)

1 Rotate the LCD monitor towards the lens side.

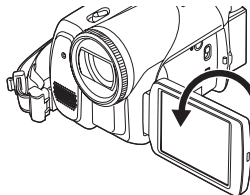

- When the LCD monitor is opened, the viewfinder will be automatically turned off. If the LCD monitor is rotated towards the lens side though, then the viewfinder will be activated.
- When the LCD monitor is rotated towards the lens side, the icon will not be displayed even if you push the center of the joystick.

Quick start

This Camcorder will be put into standby in approx. 1.7 seconds after the power is turned on.

- This is only activated in the following cases.
 - A tape or a card is inserted, while the Tape Recording Mode is set.
 - A card is inserted, while the Card Recording Mode is set.

1 Press the [QUICK START] button.

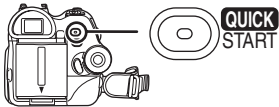

- The quick start recording lamp lights up. (Press the button again to cancel it.)

2 Set the [OFF/ON] switch to [OFF].

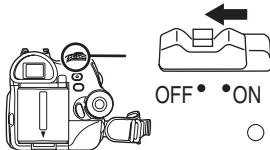

- The quick start is now ready.

3 Set the [OFF/ON] switch to [ON].

- This Camcorder will be put into a recording pause in approx. 1.7 seconds after it is turned on.

■ To cancel the quick start when the power is [OFF]

Press and hold the [QUICK START] button for approx. 2 seconds. The lamp will go off and the Camcorder will be completely turned off.

- If the standby continues for approx. 30 minutes, then the lamp will go off and the Camcorder will be completely turned off.

- When you rotate the mode dial or remove the battery, the quick start recording lamp is turned off and the quick start mode is canceled. If the Camcorder is turned on and the Tape/Card Recording Mode is set though, the lamp turns on and the quick start mode is restored.
- When the Camcorder is quick-started with the white balance on automatic, it may take some time until the white balance is adjusted if the scene being recorded has a light source different from the scene last recorded. (When the MagicPix function is used, however, the white balance of the scene last recorded is retained.)
- The zoom magnification differs from when it is in the quick start standby mode and when the recording starts.

- Since about half the power of normal recording is used in quick start standby, using quick start reduces the time during which pictures can be recorded.

Backlight compensation function

This protects a backlit subject from being darkened.

- Set to Tape/Card Recording Mode.

- 1 Press the joystick until the icon ① appears.
- 2 Move the joystick right to select the backlight compensation icon [B.C.].



- The image on the screen will become brighter.

■ To return to normal recording

Select the [B.C.] icon again.

- If you operate the [OFF/ON] switch or the mode dial, the backlight compensation is canceled.

MagicPix functions

This function allows you to record color subjects in dark locations to stand out against the background.

Attach the Camcorder to a tripod, and you can record images free from vibration.

- Only manual focusing can be used.
- Recorded scene is seen as if frames were missed.

MagicPix function

You can record dark locations brightly in color.

0 Lux MagicPix function

You can record completely dark locations with the light of the LCD monitor.

- **Set to Tape Recording Mode.**

- 1 Press the joystick until the icon ❶ appears.
- 2 Move the joystick up to select the MagicPix icon [★].



- Each upward press switches the modes.
OFF → MagicPix function → 0 Lux MagicPix function → OFF

- 3 (In the case of 0 Lux MagicPix function)
Rotate the LCD monitor towards the lens side.

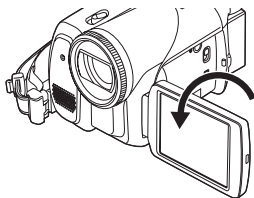

- When the LCD monitor is reversed, the Power LCD Lamp turns on and the screen is lit in white.
- Record the subject while viewing it on the viewfinder.
- The light of the LCD monitor reaches approx. 3.9 feet (1.2 m) or less.

■ To cancel the MagicPix function

Select the MagicPix icon until the MagicPix indication disappears.

- If set in a bright place, the screen may become whitish for a while.
- The MagicPix function makes the signal charging time of CCD up to approximately 30× longer than usual, so that dark scenes invisible to the naked eye can be recorded brightly. For this reason, bright dots that are usually invisible may be seen, but this is not a malfunction.
- The MagicPix function is canceled when you operate the power switch or the mode dial.

Soft skin mode

This allows the skin color to be recorded in a softer tone.

- **Set to Tape/Card Recording Mode.**

- 1 Press the joystick until the icon ❶ appears.
- 2 Move the joystick down to select the soft skin icon [☺].



■ To cancel the soft skin mode

Select the [☺] icon again.

- If the background or anything else in the scene has colors similar to the skin color, they will also be softened.
- If the brightness is insufficient, the effect may not be clear.

Tele-macro function

By focusing only on the subject and blurring the background, the image can be impressive. This Camcorder can focus on the subject at a distance of approx. 16 inches (40 cm).

●Set to Tape/Card Recording Mode.

- 1 Press the joystick until the icon ❶ appears.
- 2 Move the joystick up to select the tele-macro icon [].



- If the magnification is 10× or less, then it is automatically set to 10×.

■ To cancel the tele-macro function

Select the [] icon again.

- If a sharper focus cannot be achieved, adjust the focus manually.
- In the following cases, the tele-macro function is canceled.
 - The zoom magnification becomes lower than 10×.
 - The [OFF/ON] switch or the mode dial is operated.

Fade in/fade out function

Fade in

The image and audio gradually appear.

Fade out

The image and audio gradually disappear.

●Set to Tape Recording Mode.

- 1 Press the joystick until the icon ❶ appears.
- 2 Move the joystick left to select the fade icon [].



- 3 Press the recording start/stop button.
Start recording. (fade in)

When you start recording, the image/audio disappears completely and the image/audio gradually appears.



Pause recording. (fade out)

The image/audio gradually disappears. After the image/audio completely disappears, recording stops.



■ To cancel fading

Select the [] icon again.

■ To select the color for fade in/out

The color which appears in fading pictures can be selected.

- 1 Set [SETUP] >> [FADE COLOR] >> [WHITE] or [BLACK].

- While the fade in/fade out function is selected, it takes several seconds to display the image when you start recording images. Besides, it also takes several seconds to pause recording.

Wind noise reduction function

This reduces the wind noise coming into the microphone when recording.

●Set to Tape Recording Mode.

- 1 Set [BASIC] >> [WIND CUT] >> [ON].



■ To cancel the wind noise reduction function

Set [BASIC] >> [WIND CUT] >> [OFF].

- Reduces the wind noise depending on the wind strength. (If this function is activated in strong winds, the stereo effect may be reduced. When the wind weakens, the stereo effect will be restored.)

Self-timer recording

You can record still pictures on a card using the timer.

● Set to Card Recording Mode.

- 1 Set [BASIC] >> [SELF TIMER] >> [YES].
- 2 Press the [PHOTO SHOT] button.



- After the recording lamp and the [] indication flashes for approx. 10 seconds, recording will start. After recording, the self-timer will be canceled.

■ To stop the timer midway through

Press the [MENU] button.

- By operating the [OFF/ON] switch or mode dial, the self-timer standby mode is canceled.
- If the RapidFire Consecutive Photoshot recording is set, the maximum recordable pictures are recorded.

Recording images for wide-screen TVs

This allows you to record images compatible with wide-screen TVs.

Images are recorded with a black belt appearing along the top and bottom of the screen so that they look like theatre movies.

● Set to Tape Recording Mode.

- 1 Set [ADVANCE] >> [CINEMA] >> [ON].

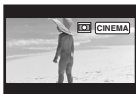

■ To cancel the Cinema function

Set [ADVANCE] >> [CINEMA] >> [OFF].

- Images played back vary depending on the TV connected. Please refer to the operating instructions for your TV.
- This function does not widen the recording range.
- When images are played back on a TV screen, the date/time indication may be erased in some cases.
- Depending on the TV, the picture quality may deteriorate.
- When a cinema picture is imported onto a personal computer, the imported picture may not be displayed correctly, depending on the software used.

Image stabilizer function

Reduces the jitter caused by hand movement when recording.

● Set to Tape Recording Mode.

- 1 Set [ADVANCE] >> [EIS] >> [ON].



■ To cancel the image stabilizer function

Set [ADVANCE] >> [EIS] >> [OFF].

- When a tripod is used, we recommend that you turn the image stabilizer function off.
- Under fluorescent lighting, image brightness may change or colors may not look natural.
- When the MagicPix function is used, the image stabilizer function does not work. If so, the [EIS] indication flashes.
- In the following cases, the image stabilizer function may not work effectively.
 - When the digital zoom is used
 - When recording is done in an extremely dark place
 - When the Camcorder is shaken greatly
 - When you record a moving subject while tracking it

RapidFire Consecutive Photoshot

Records still pictures continuously at a certain interval.

● Set to Card Recording Mode.

- 1 Set [BASIC] >> [PICTURE SIZE] >> [640].
- 2 Set [ADVANCE] >> [BURST MODE] >> [ON].



- 3 Press and hold the [PHOTO SHOT] button.



■ To stop RapidFire Consecutive Photoshot midway through

Release the [PHOTO SHOT] button.

- The Camcorder records up to 10 still pictures at intervals of 0.5 seconds. If the shutter speed is manually set to 1/30, then the still pictures can be recorded at intervals of 0.7 seconds.
- One more still picture may be recorded after you release the [PHOTO SHOT] button.
- If [SELF TIMER] >> [YES] is set, the Camcorder records the maximum number of pictures recordable.
- Intervals between recording pictures may become longer depending on the card. We recommend using a Panasonic SD Memory Card.
- When using a card formatted by other equipment or a card that was recorded and erased repeatedly, the intervals between recording pictures may become longer. If so, back up your important data on a PC, and format your card with this Camcorder.

Recording in various situations

(Scene mode)

When you record images in different situations, this mode automatically sets optimum shutter speeds and apertures.

● Set to Tape/Card Recording Mode.

- 1 Set the [AUTO/MANUAL/FOCUS] switch to [MANUAL].



- 2 Set [BASIC] >> [SCENE MODE] >> select the desired mode.

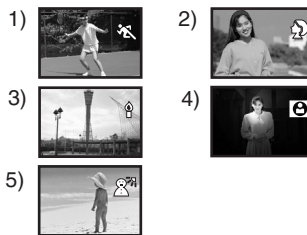

1) [🏸] Sports mode

- To record sports scenes or scenes where there are quick motions

2) [👤] Portrait mode

- To make people stand out from the background

3) [📶] Low light mode

- To record dark scenes so they are brighter

4) [📷] Spotlight mode

- To record subjects in a spotlight at a party or theatre

5) [🏄] Surf & snow mode

- To record images at very bright locations such as ski slopes and beaches

■ To cancel the scene mode function

Set [BASIC] >> [SCENE MODE] >> [OFF] or set the [AUTO/MANUAL/FOCUS] switch to [AUTO].

Sports mode

- For slow-motion playback or playback pause of recorded pictures, this mode helps diminish camera shake.
- During normal playback, the image movement may not look smooth.
- Avoid recording under fluorescent light, mercury light or sodium light because the color and brightness of the playback image may change.
- If you record a subject illuminated with strong light or a highly reflective subject, vertical lines of light may appear.
- If the brightness is insufficient, the sports mode does not function. The [] indication flashes.
- If this mode is used indoors, the screen may flicker.

Portrait mode

- If this mode is used indoors, the screen may flicker. If so, change the scene mode setting to [OFF].

Low light mode

- Extremely dark scenes may not be able to be recorded finely.

Spotlight mode

- If the recording subject is extremely bright, the recorded image may become whitish and the periphery of the recorded image extremely dark.

Surf & snow mode

- If the subject is extremely bright, the recorded image may become whitish.

Recording in natural colors (White balance)

The automatic white balance function may not reproduce natural colors depending on the scene or lighting conditions. If so, you can adjust the white balance manually.

- **Set to Tape/Card Recording Mode.**

1 Set the [AUTO/MANUAL/FOCUS] switch to [MANUAL].



2 Move the joystick down until the white balance indication appears. ([AWB] etc.).



3 Move the joystick left or right in order to select the white balance mode.

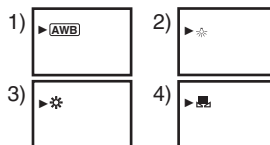



- 1) Auto white balance adjustment [**[AWB]**]
- 2) Indoor mode (for recording under incandescent lamps) [**[]**]
- 3) Outdoor mode [**[]**]
- 4) Manual adjustment mode [**[]**]

■ To restore to the automatic adjustment

Move the joystick left or right until the [**[AWB]**] indication appears. Or, set the [AUTO/MANUAL/FOCUS] switch to [AUTO].

- When the Camcorder is turned on with the lens cap fitted, the automatic white balance adjustment may not function properly. Please turn the Camcorder on after removing the lens cap.
- When setting both the white balance and the iris/gain, set the white balance first.
- Whenever recording conditions change, re-set the white balance for correct adjustment.

■ To set the white balance manually

Select [] in Step 3. Then, while viewing a white subject on the entire screen, move the joystick up to select the [] indication.

■ About flashing of the [] indication

When the manual adjustment mode is selected

- Flashing indicates that the white balance previously adjusted is stored. This setting is stored until the white balance is adjusted again.

When white balance cannot be set in the manual adjustment mode

- White balance may not be adjusted properly in the manual adjustment mode in dark places. If so, use the auto white balance mode.

During setting in the manual adjustment mode

- When the setting is completed, it will remain lit.

■ About the white balance sensor

The white balance sensor detects the type of light source during recording.

- Do not cover the white balance sensor during recording, or it may not function properly.

■ About the black balance adjustment

This is one of the 3-CCD system functions that automatically adjusts the black when the white balance is set in the manual adjustment mode. When the black balance is adjusted, the screen will temporarily be black.

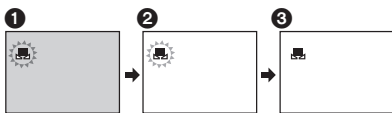

- 1 Black balance adjustment (Flashes.)
- 2 White balance adjustment (Flashes.)
- 3 Adjustment completed (Lights up.)

Manual focus adjustment

If auto focusing is difficult due to the conditions, then manual focusing is available.

● Set to Tape/Card Recording Mode.

- 1 Set the [AUTO/MANUAL/FOCUS] switch to [MANUAL].



- 2 Set the [AUTO/MANUAL/FOCUS] switch to [FOCUS].



- The MNL and the manual focus indication [MF] will be displayed.

- 3 Move the joystick left or right in order to adjust the focus.



- When focused with a wide angle, the subject may not be in focus when zoomed in. First, zoom in on the subject, and then focus on it.

■ To restore to the automatic adjustment

Set the [AUTO/MANUAL/FOCUS] switch to [AUTO] or [FOCUS].

Manual shutter speed/aperture adjustment

Shutter Speed

Adjust it when recording fast-moving subjects.

Aperture

Adjust it when the screen is too bright or too dark.

● Set to Tape/Card Recording Mode.

- 1 Set the [AUTO/MANUAL/FOCUS] switch to [MANUAL].



- 2 Move the joystick down until the shutter speed indication or aperture value indication appears.



- 1) Shutter speed
- 2) (Aperture) Iris/gain value

- 3 Move the joystick left or right in order to adjust the shutter speed or aperture.

■ To restore to automatic adjustment

Set the [AUTO/MANUAL/FOCUS] switch to [AUTO].

Manual shutter speed adjustment

- Avoid recording under fluorescent light, mercury light or sodium light because the color and brightness of the playback image may change.
- If you increase the shutter speed manually, the sensitivity lowers and accordingly the gain value increases automatically, which may increase the noises on the screen.
- You may see vertical lines of light in the playback image of a brightly shining subject or highly reflective subject, but this is not a malfunction.
- During normal playback, image movement may not look smooth.
- When recording in an extremely bright place, the color of the screen may change or flicker. If this happens adjust the shutter speed manually to 1/60 or 1/100.

Manual iris/gain adjustment

- If the value does not become "OPEN", you cannot adjust the gain value.
- If the gain value is increased, the noise on the screen increases.
- Depending on the zoom magnification, there are iris values that are not displayed.

■ Shutter speed range

1/60–1/8000 seconds: Tape Recording Mode

1/30–1/500 seconds: Card Recording Mode

The shutter speed closer to 1/8000 is faster.

■ Iris/gain value range

CLOSE (Closed), F16, ..., F2.0,

OPEN (Opened) 0dB, ..., 18dB

Value closer to [CLOSE] darken the image.

Value closer to [18dB] brighten the image.

Values with dB are gain values.

Playback mode

Playing back tape

● Set to Tape Playback Mode.

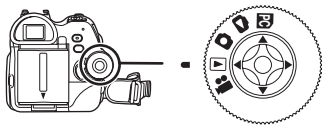

1 Operate with joystick.



- ▶/||: Playback/Pause
- ◀◀: Rewind/Review playback (Reverts to playback with the ▶/|| icon.)
- ▶▶: Fast forward/Cue playback (Reverts to playback with the ▶/|| icon.)
- : Stop

- During cue/review playback, fast-moving images may show noise as a mosaic.
- Before and after cue/review playback, the screen may become blue for a moment or images may be distorted.

■ To adjust volume

Adjust the speaker or headphone volume for playback.

1 Move the [- VOL+] lever to adjust the volume.

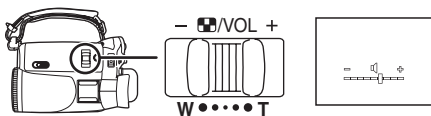

Towards [+]: increases the volume
 Towards [-]: decreases the volume
 (The closer to [+], the higher the volume.)

- On the remote control, press the [T] button to increase the volume or the [W] button to decrease it.
- When the adjustment is completed, the volume indication will disappear.
- If you do not hear the sound, check the settings of [SETUP] >> [12bit AUDIO].

■ Repeat playback

When the tape end is reached, the tape will be rewound and played back again.

1 Set [ADVANCE] >> [REPEAT PLAY] >> [ON].

- The [↺▶] indication appears. (In order to cancel the repeat playback mode, set [REPEAT PLAY] >> [OFF] or set [OFF/ON] switch to [OFF].)

■ Settings on the audio

- If you cannot listen to the desired audio when playing back a tape, check the settings in [SETUP] >> [12bit AUDIO].
- When you record or dub the audio in [12bit] and set [SETUP] >> [12bit AUDIO] >> [MIX], the audio will be played back in stereo sound regardless of the settings in [AUDIO OUT].

Slow-motion playback/ frame-by-frame playback

● Set to Tape Playback Mode. (Slow-motion playback can only be performed by using the remote control.)

Slow-motion playback

If the image is recorded in the SP mode, then it will be played back at a speed approx. 1/5 the normal speed.

If the image is recorded in the LP mode, then it will be played back at a speed approx. 1/3 the normal speed.

1 Press the [◀] button or the [▶] button on the remote control.

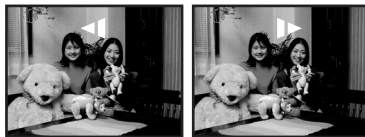
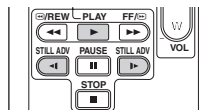

- If the slow-motion playback continues for approx. 10 minutes or more, then the playback will automatically stop. (10 minutes of slow-motion playback is equivalent to approx. 2 minutes in the SP mode or approx. 3 minutes in the LP mode.)

Frame-by-frame playback

- 1 During playback, press the [II] button on the remote control.
- 2 Press the [◀] button or the [▶] button on the remote control.

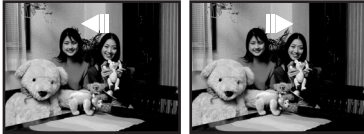
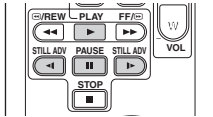

- Pushing the [-VOL+/VOL+] lever towards [T] (normal direction) or towards [W] (reversed direction) of this Camcorder during playback pause also turns into the frame-by-frame playback. If you keep pushing the lever, then the images will continuously be played back frame by frame.

■ To return to normal playback

Press the [▶] button on the remote control.

Slow-motion playback

- In the reversed slow-motion playback, the time code indication may be unstable.

Frame-by-frame playback

- Press and hold the [◀] or the [▶] button in the playback pause, and then the images will continuously be played back frame by frame.

Variable-speed search function

The speed of cue/review playback can be varied. (This operation is only available when using the remote control.)

- Set to Tape Playback Mode and play back a tape.

- 1 Press the [VAR. SEARCH] button on the remote control.



- 2 Press the [▲] or [▼] button up or down to vary the speed.

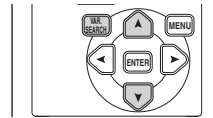

- The speeds for cue/review playback are 1/5× (SP mode slow-motion playback only), 1/3× (LP mode slow-motion playback only), 2×, 5×, 10×, 20×.

■ To return to normal playback

Press the [VAR. SEARCH] button or [▶] button on the remote control.

- Images may be shown in a mosaic-like pattern.
- The sound is muted during search.
- This function is canceled when the operation icon is displayed.

Playback on TV

Images recorded by this Camcorder can be played back on a TV.

- Insert a recorded tape into this Camcorder.

1 Connect the Camcorder to a TV.

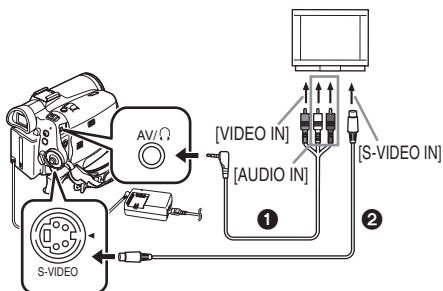

- Connect the Camcorder and the TV by using the AV cable ①.
- If the TV has an S-Video terminal, then also connect an S-Video cable ② (optional). An S-video connection allows you to enjoy a higher quality image.

2 Turn on this Camcorder and set the mode dial to the Tape Playback Mode.

3 Select the input channel on the TV.

4 Move the joystick up to select the [▶/||] icon to start playback.

- The image and audio are output on the TV.

5 Move the joystick down to select the [■] icon to stop playback.

- Whenever plugging in the S-Video cable, plug in the AV cable, too.
- Use the AC adaptor to avoid battery depletion.

■ If the image or audio from this Camcorder is not output on the TV

- Check that the plugs are inserted as far as they go.
- Check the connected terminal.
- If the image does not appear on the TV even if [BASIC] >> [AV JACK] >> [OUT/Ω] are set, then set to [OUT]. (-51-)
- Check the TV's input setting (input switch). (For more information, please read the operating instructions for the TV.)

■ To display the on-screen information on the TV

The information displayed on the LCD monitor or the viewfinder (operation icon, time code and mode indication, etc.), date and time can be displayed on the TV.

1 Press the [OSD] button on the remote control.

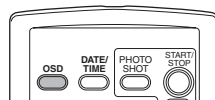

- Press the button again to erase the OSD information.

Playing back card

● Set to Picture Playback Mode.

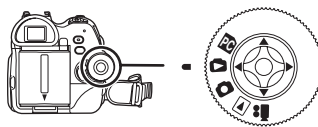

1 Operate with joystick.



- ◀: Plays back the previous picture.
- ▶: Plays back the next picture.
- ▶/■: Slide show (Plays back the still pictures on the card in order) start/stop

- While the data on a card is playing back, do not operate the mode dial.
- When the access lamp is lit, do not insert or remove a card.
- It takes time to display the file depending on the number of pixels of the file.
- If you attempt to play back file recorded in a different format or file data is defective, the whole display becomes bluish and the "UNPLAYABLE CARD" indication may appear as a warning.
- When playing back a file recorded on other equipment, the date and time display is different from when it was recorded.
- When playing back a picture recorded on other equipment, its size and that of pictures recorded by this Camcorder may appear differently.

■ To display multiple playback files

Multiple files on the card (6 files on 1 screen) are displayed.

- 1 Move the [-  /VOL+] lever to switch the images.

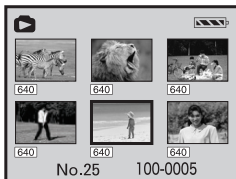

- Towards [+]: Full-screen display
(Displays 1 image.)
- Towards [-]: Multi-screen display
(Displays 6 files on 1 screen.)

- In the multi-screen display,
 - Move the joystick to select a file (The selected file will be encircled by a yellow frame) and press it. The selected file is full-screen displayed.
 - If there are 7 files or more, move the joystick. The next, or previous multi-screen will be displayed.

■ About the compatibility of still pictures

- The Camcorder is compliant with the unified standard DCF (Design rule for Camera File system) established by JEITA (Japan Electronics and Information Technology Industries Association).
- The file format supported by this Camcorder is JPEG. (Not all JPEG formatted files will be played back.)
- If a non-standard file is played back, the folder/file name may not be displayed.
- The Camcorder may degrade or not play back data recorded or created on another product and another product may degrade or not play back data recorded with the Camcorder.

Deleting files recorded on a card

The deleted files cannot be restored.

- Set to Picture Playback Mode.

- 1 Move the joystick left or right to select a file to delete.



- You can select a file in the multi-screen display. After selecting the file, press the joystick and display the operation icon.

- 2 Move the joystick down to select [].



- 3 Move the joystick up or down in order to select [DELETE 1 FILE] and then press it.

- 4 When the confirming message appears, select [YES] and press the joystick.

- In order to stop deletion, select [NO].

■ To delete all files

- 1 Move the joystick down to select [].



- 2 Move the joystick up or down in order to select [ALL FILES] and then press it.

- 3 When the confirming message appears, select [YES] and press the joystick.

- In case of [ALL FILES], the deletion may take time if there are many files on the card.
- When "CARD FULL" is shown during recording, switch to the Picture Playback Mode and then delete unnecessary files.
- If there are not any file to delete, insert a new card.
- If files conforming to DCF standard are deleted, all the data related to the files will be deleted.

■ Deleting still picture files recorded on a card by other equipment

- A still picture file (other than JPEG) that cannot be played back on the Camcorder may be erased.

Formatting a card

Please be aware that if a card is formatted, then all the data recorded on the card will be erased. Store important data on a personal computer, etc.

● Set to Picture Playback Mode.

- 1 Set [ADVANCE] >> [CARD FORMAT] >> [YES].
- 2 When the confirmation message appears, select [YES] and press the joystick in order to format the card.

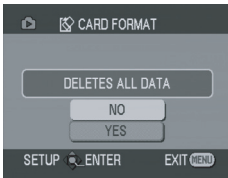

- In order to stop formatting, select [NO].

- Normally, it is not necessary to format the card. If a message appears even though you insert and remove the card several times, format it.
- Cards formatted on other equipment such as personal computers cannot be used or recording takes longer than usual. We recommend formatting your card on this Camcorder.

Protecting files on a card

Files recorded on a card can be locked so that they may not be deleted by mistake. (Even if the files are locked, they will be deleted if the card is formatted.)

● Set to Picture Playback Mode.

- 1 Set [BASIC] >> [PROTECT] >> [YES].
- 2 Move the joystick to select a file to be locked, and then press it.



- [LOCK] Indication ① appears and the selected file is locked. Press the joystick again, and the lock will be canceled.
- 2 or more files can be locked in succession.

■ To complete the settings

Press the [MENU] button.

Writing the printing data on a card (DPOF setting)

You can write the data of pictures to be printed, number of copies, and other information (DPOF data) onto the card.

● Set to Picture Playback Mode.

- 1 Set [ADVANCE] >> [DPOF SET] >> [SET].
- 2 Move the joystick to select a file to be set, and then press it.



- The number of prints ① to be set in DPOF is displayed.
- 3 Move the joystick up or down in order to select the number of prints and then press it.
 - You can select from 0 to 999. (Some copies of the picture can be printed as you set the number of prints with the printer supporting DPOF.)
 - 2 or more files can be set in succession.

■ To complete the settings

Press the [MENU] button.

- DPOF setting made on another Camcorder may not be recognised by this Camcorder. Please perform the DPOF settings on your Camcorder.

■ To set so that all pictures are not printed

Select [CANCEL ALL] in Step 1.

■ What is DPOF?

DPOF stands for Digital Print Order Format. This enables the printing information to be added to the pictures on the card so that it can be used on a system supporting DPOF.

Edit mode

Recording from a tape onto a card

Still pictures can be recorded on a memory card from scenes that have already been recorded on a cassette.

- Set to Tape Playback Mode.
- Insert a tape which already has recorded contents and a card.

1 Start playback.



2 Pause at the scene you wish to record, and press the [PHOTO SHOT] button.



- Audio will not be recorded.

- The size of still pictures recorded on a card becomes [640]. (This is not mega pixel still-picture recording.)
- If you press the [PHOTO SHOT] button without pausing, blurred pictures may be recorded.
- DV input and wide images recorded on a tape cannot be recorded on a card.

Copying onto a DVD recorder or a VCR (Dubbing)

Pictures recorded by the Camcorder can be stored on a DVD-RAM or other such media. Refer to the instructions for the recorder.

- Place a recorded cassette in the Camcorder, and an unrecorded DVD-RAM or cassette in the DVD recorder or VCR.

1 Connect the Camcorder and the recorder.

Connecting with the AV cable

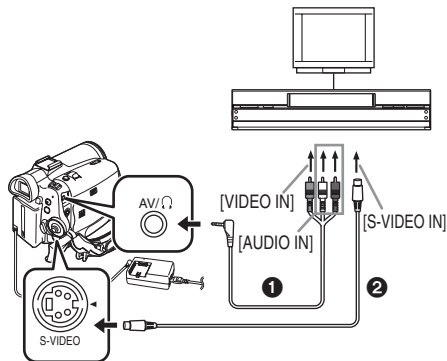

- Connect the Camcorder and the recorder by using the AV cable ①.
- If the recorder has an S-Video terminal, then also connect an S-Video cable ② (optional). An S-video connection allows you to copy a high quality image.

Connecting with the optional DV cable (Only for equipment with a DV terminal)

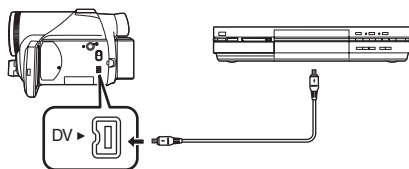

- 2 Turn on the Camcorder and set to Tape Playback Mode.
- 3 Select the input channel on the TV set and recorder.
- 4 Move the joystick up to select the [▶] icon to start playback.
 - The image and sound are reproduced.
- 5 Start recording.
- 6 Move the joystick down to select the [■] icon to stop playback.
- 7 Stop recording.

- For more information, refer to the operating instructions for your TV set and recorder.
- When you do not need functional indications or date and time indications, press the [OSD] button on the remote control for no indication. (When you connect the Camcorder and a recorder with the DV cable, these indications may not appear.)

■ When neither image nor sound from the Camcorder is output to the TV set

- Check that the plugs are inserted as far as they go.
- Check the connected terminal.
- When no image is presented on the TV even if set [BASIC] >> [AV JACK] >> [OUT/], set to [OUT]. (-51-)

Using the DV cable for Recording (Digital Dubbing)

By connecting other digital video equipment with DV terminal and the Camcorder by using the DV cable PV-DDC9/PV-DDC9-K (optional) ①, high-image-quality dubbing can be done in digital format.

• Set to Tape Playback Mode. (Player/recorder)

1 Connect the Camcorder and digital video equipment with the DV cable.

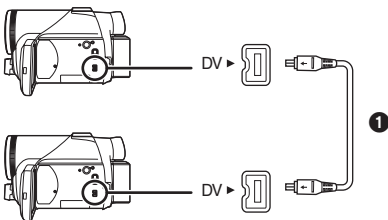

2 Set [ADVANCE] >> [REC STDBY] >> [YES]. (Recorder)

- You do not have to follow this step when the remote control is used in the digital dubbing.

3 Start playback. (Player)

4 Start recording. (Recorder)

Move the joystick up to select [●/II] icon.



Or, while pressing the [●REC] button on the remote control, press the [▶] button.

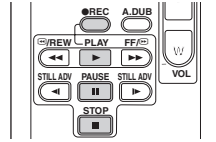

5 Move the joystick up to select the [●/II] icon again or press the [II] button on the remote control to stop recording.

(Recorder)

6 Stop playback. (Player)

■ To cancel the standby for recording

When the Camcorder is in standby for recording, move the joystick down and select the [■] icon.

- Do not plug or unplug the DV cable during dubbing, or the dubbing may not be completed properly.
- If a picture (bilingual video, etc.) containing main sound and sub sound has been dubbed, select the desired sound using [SETUP] >> [AUDIO OUT] on playback.
- Even if you use a device equipped with DV terminals such as IEEE1394, you may not be able to perform digital dubbing in some cases. For more information, see the instructions for equipment connected.
- Regardless of the menu settings on the recorder, digital dubbing is carried out in the same mode as the [AUDIO REC] mode of the playback tape.
- The images on the recorder monitor may be disturbed, but it does not affect the recorded images.
- If a picture containing a copyright protection signal (copy guard) is recorded by the Camcorder, the picture is distorted by mosaic-like patterns at playback.
- Disconnect the USB cable since input signals from the external input terminal cannot be recorded while it is connected with the USB cable.
- When wide images are input, the display such as the menu screen or the operation icon is expanded horizontally.
- While pictures are input from the DV terminal, The operation icon blinks on instead of appearing from the side of the screen when you press the center of the joy stick.

CAUTION:
Unauthorized exchanging and/or copying of copyrighted recordings may be copyright infringement.

Audio dubbing

You can add music or narration to the recorded cassette.

● Set to Tape Playback Mode.

- 1 Insert an external microphone securely into the [MIC] terminal as far as it will go.

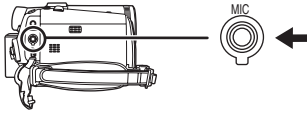

- 2 Find a scene that you want to add sound to, and press the [II] button on the remote control.

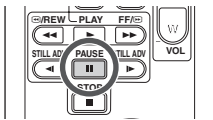

- 3 Press the [A.DUB] button on the remote control to make audio dubbing ready.

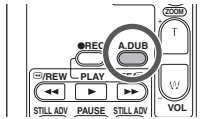

- 4 Press the [II] button on the remote control to start audio dubbing.

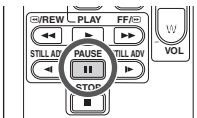

- Talk into the microphone.

- 5 Press the [II] button on the remote control to stop audio dubbing.

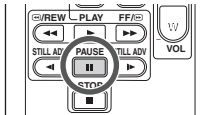

- If a tape has a non-recorded portion when the tape is dubbed, images and sounds may be disturbed when this portion of the tape is played back.

■ Before recording with audio dubbing

● Set to Tape Recording Mode.

- When you want to preserve the original sound taken during recording, set [SETUP] >> [AUDIO REC] >> [12bit] to take pictures. (When set [16bit], the sounds taken during recording are erased after recording with audio dubbing.)
- Set [BASIC] >> [REC SPEED] >> [SP] to take pictures.

■ To play back the sound recorded with audio dubbing

You can switch between the sound recorded with audio dubbing and the original sound.

Set [SETUP] >> [12bit AUDIO] >> [ST2] or [MIX].

[ST1]: It only plays back the original sound.

[ST2]: It only plays back the sound added by audio dubbing.

[MIX]: It simultaneously plays back the original sound and the sound added with audio dubbing.

■ To dub audio while listening to a pre-recorded sound

- When a microphone is used for audio dubbing, use headphones to listen to the pre-recorded sound while dubbing the audio. (When using headphones, set [AV JACK] >> [OUT/⏏].)

When you set [SETUP] >> [12bit AUDIO] >> [ST2], you can check the pre-recorded sound.

Printing pictures by directly connecting to the printer (PictBridge)

To print pictures by directly connecting the Camcorder to the printer, use a printer compatible with PictBridge. (Read the operating instructions for the printer.)

● Insert a card and set to Picture Playback Mode.

1 Connect the Camcorder and the printer with the supplied USB cable.

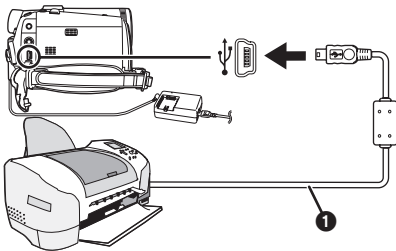

1 USB cable



- The [PictBridge] indication appears on the screen of the Camcorder. (When the printer is being recognized, the [PictBridge] indication blinks.)
- When no card is inserted in the Camcorder, the [PictBridge] indication does not appear. (You cannot print any pictures.)
- When the Camcorder and the printer are not connected properly, the [PictBridge] indication keeps blinking. (It will blink for just over 1 minute.) Connect the cable or check the printer.
- We recommend using the AC adaptor as the power supply.
- When images are displayed in multi-screen, they cannot be printed.

2 Select [SINGLE PRINT] or [DPOF PRINT].

- If there is no file with a DPOF setting, you cannot select [DPOF PRINT].
- When you select [DPOF PRINT] for printing set the number of prints in DPOF setting.
- When [DPOF PRINT] is selected, print after you determine the paper size.

3 Move the joystick left and right to select a desired picture, and then press it.



4 Select the desired number of prints.

- You can set up to 9 prints.

5 Select the setting for date printing.

- If the printer is not capable of date printing, this setting will be unavailable.

6 Select the paper size.

[STANDARD]: Size specific to the printer

[4×5 INCH]

[5×7 INCH]

[4×6 INCH]

[A4]

- You cannot set paper sizes not supported on the printer.

7 Set [PRINT] >> [YES] to start printing.

■ When you stop printing halfway

Move the joystick down.

- Avoid the following operations during printing. These operations disable proper printing.
 - Disconnecting the USB cable
 - Removing the card
 - Switching the mode dial
 - Turning off the power
- Check the settings for the paper size, quality of print, etc. on the printer.
- You cannot print pictures that cannot be played on the Camcorder.

Connecting Computer and Camcorder

Before making these connections, turn off all devices which are to be connected.

- It is recommended that you use the AC Adaptor as the power supply of the Camcorder.

Operating environment

For Windows

OS:

IBM PC/AT compatible personal computer with pre-installed;

Microsoft Windows 98 Second Edition

CPU:

Intel Pentium II/Celeron 300 MHz or higher (including compatible CPU)

RAM:

32 MB or more (64 MB or more recommended)

Interface:

USB

- For Windows Me/2000/XP users, the USB equipment operates with the driver installed as standard in OS.

For Macintosh

OS:

Mac OS X v 10.1–X v 10.3

CPU:

iMac, iBook or Power Book G4, Power Mac G4 or Power Mac G5

RAM:

64 MB or more

- The USB equipment operates with the driver installed as standard in OS.

Installing the USB Driver

- If you have direct dial-up connection capability to the Internet, please download the USB Driver.
- Please install USB Driver first before connecting the Camcorder to your personal computer with the USB Cable.

For USA Customers

- 1 In order to download and install the USB Driver, go to <http://www.panasonic.com/consumerdownloads>



- 2 Click [Camcorder] on the screen.
- 3 Click [USB Driver version 1.00].

For Canadian Customers

- 1 In order to download and install the USB Driver, go to <http://www.panasonic.ca/english/customer-care/downloads.asp>



- 2 Click [software & drivers].
- Select [Camcorder] in the Category menu.
- 3 Click [USB Driver version 1.00].

For both USA and Canadian Customers

- 4 Decompress the downloaded data.
- 5 Double click  icon.
 - The set up program starts running.
- 6 Click [Restart] if the [InstallShield] dialog appears.



- 7 Finish installation by following the on-screen instructions.
 - Click [Next] and proceed with installation.
 - After completing the installation, Click [Finish].
- 8 After the USB Driver is installed, please restart your computer.

For Windows 98SE Users

The following messages may be displayed when connecting this Camcorder and your personal computer via USB Cable.

- 1) The message "MTDV98M3.pdr is not found" is displayed.
 - Enter "C:\Windows\system\IOSUBSYS"
 - 2) The message "MTDV98M3.sys is not found" is displayed.
 - Enter "C:\Windows\SYSTEM32\DRIVERS".
- You may click [Browse] to look for and assign the path.

■ Using Built-in SD Drive

By connecting the Camcorder and personal computer with the USB Cable, you can transfer still images saved on a Memory Card directly to your personal computer.

- 1 Insert the Memory Card into the Camcorder.
- 2 Set the Camcorder to PC Mode.

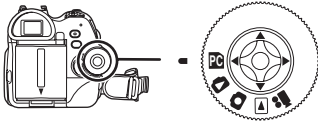

- 3 Connect the Camcorder to your personal computer with the USB Cable.

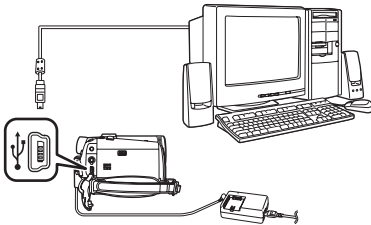

- It enters PC Connecting Mode.

- 4 Open [My Computer] and click [Removable Disk] (For Windows Me/ 2000 users).

Click [Open folder to view files using Windows Explorer] and then [OK] (For Windows XP users).

- 5 Double-click a file you want to view.

- You can view images stored on the Memory Card and also save them to your hard disk.
- Please do not change file or folder names on the personal computer. The images on the Memory Card may then not be viewable on the Camcorder.
- After making the connections, turn the connected equipment on.
- Appropriate driver to recognize Camcorder is automatically installed by Windows Plug and Play when connected for the first time.

To disconnect USB Cable safely

If USB Cable is disconnected while computer is on, error dialog box may appear. In such a case click [OK] and close the dialog box. By following the steps below you can disconnect the cable safely.

- 1 Double click the  icon in task tray.
 - Hardware disconnect dialog box appears.



- 2 Select [USB Mass Storage Device] and click [Stop].

- 3 Verify [Matshita DVC USB Device] is selected and click [OK].



- You can safely disconnect the cable.

Note on the driver name displayed

The driver name displayed will differ depending on your OS, operating environment and the mode of the Camcorder.

- Some Operating Systems may not show the icon indicating that you may safely disconnect in task tray. (OS may be set not to show.) Make sure Camcorder's Card Access Lamp is off and disconnect the cable. Also, with Windows Me, the icon will not be displayed when in Tape Recording Mode or Tape Playback Mode.

CAUTION:

If you disconnect the USB Cable while the Card Access Lamp is on, it may damage the Card data.

If the above operation is not performed correctly, when data is copied from the personal computer to an SD Memory Card, the copied data may be damaged.

When the following operations are performed, the same results will occur as when the USB Cable is incorrectly removed (above). Therefore, it is imperative that the above operation is completed before proceeding.

- When SD Memory Card is removed.
- When Camcorder power is turned OFF.

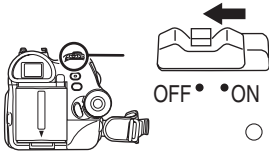

- When Mode Dial is turned to change modes.

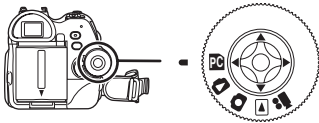

- Microsoft[®], Windows[®], Windows Messenger[®] and DirectX[®] are either registered trademarks or trademarks of the Microsoft Corporation in the United States and/or other countries.
- Intel[®], Pentium[®] and Celeron[®] are the registered trademarks or trademarks of the Intel Corporation.
- All other names, company names, product names, etc. in these instructions are the trademarks or registered trademarks of their respective corporations.
- The names of the products you are using may differ from the names given in the text. Depending on the operating environment and other factors, the contents of the screens used in these instructions may not necessarily match what you will see on your screen.
- Although the screens in these Operating Instructions are shown in English for the sake of example, other languages are supported as well.
- These instructions do not cover the basic operations of the personal computer or define any terms. For this information, refer to the Operating Instructions which accompany your personal computer.
- Do not disconnect USB Connection Cable while the operation light of Camcorder is on. It may freeze the software or destroy the data in transfer.

- We recommend using the AC adaptor as the power source for the Camcorder when connecting to the personal computer. Data may be lost if the battery power is lost while transferring data.
- Do not delete the folders in Memory Card such as picture folder. Memory card may not be recognized if folders are deleted.
- When the Camcorder is switched to the PC Mode while it is connected to the personal computer, the operation mode of the Camcorder cannot be switched. In this case, disconnect the USB Connection Cable. Switch the operation mode of the Camcorder and reconnect the Cable.
- If the Camcorder is connected in the PC Mode, the [Removable Disk] icon representing the Memory Card drive is displayed in [My Computer].

Menu

Menu list

Menu figures and illustrations are provided for easy-to-understand explanations, and so they are different from the actual menu indications.

■ [TAPE RECORDING MENU]

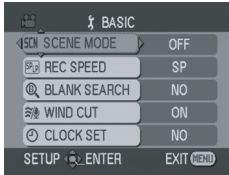

1) [BASIC]

- [SCENE MODE] -33-
- [REC SPEED] -24-
- [BLANK SEARCH] -26-
- [WIND CUT] -31-
- [CLOCK SET] -20-

2) [ADVANCE]

- [PICT. QUALITY] -27-
- [EIS] -32-
- [CINEMA] -32-
- [D.ZOOM] -28-
- [ZOOM MIC] -28-
- [DATE/TIME] -51-
- [INITIAL SET] -52-

3) [SETUP]

- [FADE COLOR] -31-
- [AUDIO REC] -51-
- [REC LAMP] -51-
- [DISPLAY] -51-
- [REMOTE] -23-
- [BEEP SOUND] -51-
- [LCD SET] -21-
- [EVF SET] -21-
- [DEMO MODE] -52-
- [AV JACK] -51-
- [POWER SAVE] -25-

4) [LANGUAGE] -19-

■ [TAPE PLAYBACK MENU]



1) [BASIC]

- [DATE/TIME] -51-
- [AV JACK] -51-

2) [ADVANCE]

- [BLANK SEARCH] -26-
- [REC SPEED] -24-
- [REC STDBY] -43-
- [REC DATA] -51-
- [PICT. QUALITY] -27-
- [REPEAT PLAY] -37-

3) [SETUP]

- [12bit AUDIO] -44-
- [AUDIO OUT] -51-
- [DISPLAY] -51-
- [REMOTE] -23-
- [LCD SET] -21-
- [EVF SET] -21-
- [POWER SAVE] -25-

4) [LANGUAGE] -19-

■ [CARD RECORDING MENU]



- 1) [BASIC]
 [SCENE MODE] -33-
 [PICT. QUALITY] -27-
 [PICTURE SIZE] -27-
 [SELF TIMER] -32-
 [CLOCK SET] -20-
- 2) [ADVANCE]
 [BURST MODE] -33-
 [SHTR EFFECT] -27-
 [DATE/TIME] -51-
 [INITIAL SET] -52-
- 3) [SETUP]
 [REC LAMP] -51-
 [DISPLAY] -51-
 [REMOTE] -23-
 [BEEP SOUND] -51-
 [LCD SET] -21-
 [EVF SET] -21-
 [POWER SAVE] -25-
- 4) [LANGUAGE] -19-

■ [PICTURE PLAYBACK MENU]



- 1) [BASIC]
 [DATE/TIME] -51-
 [PROTECT] -41-
- 2) [ADVANCE]
 [DPOF SET] -41-
 [CARD FORMAT] -41-
- 3) [SETUP]
 [DISPLAY] -51-
 [REMOTE] -23-
 [LCD SET] -21-
 [EVF SET] -21-
 [POWER SAVE] -25-
- 4) [LANGUAGE] -19-

Menus related to taking pictures

■ [DATE/TIME]

This switches between date and time indications.

- The Camcorder automatically records the date and time the picture was taken on the tape.
- You can also show or change the date/time indication by repeatedly pressing the [DATE/TIME] button on the remote control.

■ [AUDIO REC]

Switches the audio (PCM audio) recording systems.

[12bit]: Records audio in "12 bit 32 kHz 4 tracks".
(The original audio signals can be kept after the other audio signals are dubbed.)

[16bit]: Records audio in "16 bit 48 kHz 2 tracks".
Audio can be recorded in higher quality.
(If audio signals are dubbed, then the original audio signals will be erased.)

■ [REC LAMP]

Set to [ON] and this turns the recording lamp on during recording, which indicates that recording is underway. Set to [OFF] and this does not turn on the lamp even when recording is underway.

■ [DISPLAY]

Set to [ON] and the display mode can be switched to all functions. Set to [OFF] and it can be switched to minimum display.

■ [BEEP SOUND]

Set to [ON] and confirmation/alarm beeps are issued as follows.

1 Beep

- When you start recording
- When you turn on the power

2 Beeps

- When you pause recording

2 Beeps for 4 times

- When a cassette with its erasure prevention tab set to [SAVE] is inserted, condensation occurs, and at other times. Check the sentence displayed on the screen.

Menus related to playback

■ [AV JACK]

This switches among the output settings of the AV/headphone terminal.

[OUT/🔊]: Automatically switches between AV and headphone output.

[OUT]: Use this setting when image or sound is not output normally to the TV in [OUT/🔊].

- When using the headphone, set to [SETUP] or [BASIC] >> [AV JACK] >> [OUT/🔊]. If set to [OUT], you may hear noises on the right.

■ [REC DATA]

Set to [ON] and the settings (shutter speed, iris/gain values, and white balance settings (-34-), etc.) used during the recordings are displayed during playback.

- When the [AUTO/MANUAL/FOCUS] switch is set to [AUTO], the indication [AUTO] will appear.
- When there is no data, [---] appears on the display.
- If the Camcorder data of the Camcorder are played back on other equipment, the settings information is sometimes not displayed normally.

■ [AUDIO OUT]

This switches the sound to be played back.

[STEREO]: Stereo sound (main sound and sub sound)

[L]: Left channel sound (main sound)

[R]: Right channel sound (sub sound)

Other menus

■ [INITIAL SET]

When there is a menu that cannot be selected depending on a combination of functions, set to [YES] for changing the menu settings back to the initial shipping condition.

(Language setting cannot be back to the initial shipping condition.)

■ [DEMO MODE]

If you set to [DEMO MODE] >> [ON] without inserting a cassette and a card, the Camcorder is automatically set to the demonstration mode for introducing its functions. If any button is pressed or operated, the demonstration mode is canceled. If no operations take place for approx.

10 minutes, the demonstration mode automatically starts. To terminate the demonstration mode, insert a cassette or a card, or set to [DEMO MODE] >> [OFF]. For normal use, set this function to [OFF].

Others

Indications

Various functions and the Camcorder status are shown on the screen.

Basic indications

- : Remaining battery power
- 0h00m00s00f: Time code
- 3:30:45PM: Date/Time indication

Recording indications

- R 0:45: Remaining tape time
- Remaining tape time is indicated in minutes. (When it reaches less than 3 minutes, the indication starts flashing.)

SP: Standard Play mode
(Recording speed mode) -24-

LP: Long Play mode
(Recording speed mode) -24-

●: Recording -25-

|| (Green): Recording pause -25-

|| (Green flash):

Standby mode
Fade out

: Recording check -26-

 CINEMA: Cinema mode -32-

: Digital zoom -28-

AUTO: Automatic mode -24-

MNL: Manual mode -33-

MF: Manual focus -35-

5×: Zoom magnification indication
-27-

: Back light mode -29-

EIS: Image stabilizer -32-

1/500: Shutter speed -36-

F2.4: F number -36-

6dB: Gain value -36-

: Soft skin mode -30-

: Tele macro -31-

 W: Fade (White) -31-

 B: Fade (Black) -31-

: MagicPix function -30-

0Lux : 0 Lux MagicPix function -30-

ZOOM : Zoom microphone -28-

: Wind noise reduction -31-

: Sports mode (Scene mode) -33-

: Portrait mode (Scene mode) -33-

: Low light mode (Scene mode)
-33-

: Spotlight mode (Scene mode)
-33-

: Surf & snow mode (Scene mode)
-33-

AWB: Auto white balance -34-



Indoor mode (recording under incandescent lamp) -34-



Outdoor mode -34-



White balance adjustment mode
-34-

Playback indications

●: Recording underway

▶: Playback -37-

||: Pause -37-

▶▶: Fast-forward/Cue playback -37-

◀◀: Rewind/Review playback -37-

▶/◀: Slow motion playback -37-

|||/◀|||: Frame-by-frame playback -37-

2×▶▶: Variable-speed search -38-

🔄▶▶: Repeat playback -37-

A.DUB ●: Audio dubbing -44-

A.DUB ||: Audio dubbing pause -44-

🔍: Blank search -26-

12bit, 16bit: Audio recording mode -51-

🔊: Volume adjustment -37-

Card

: Progressive photoshot mode -27-

: RapidFire Consecutive Photoshot recording -33-



: Self-Timer recording -32-

 (White): Photoshot mode

 (Green): While the card is being read

: While photoshot recording is activated

 (Red): Using the card that cannot be recognized

 (): Photoshot picture quality -27-

0: Remaining number of photoshot pictures (When the remaining number of photoshot pictures reaches 0, the red indication flashes.)

: Slide show playback -39-

PictBridge: PictBridge mode -45-

100-0001: Folder/File display

No.00: File number

1: Number of DPOF Setting -41-

: Lock setting -41-

 [640]: [640×480] Image size

 [1280]: [1280×960] Image size

● For images not recorded with this Camcorder,

the size display is determined as follows according to the number of horizontal pixels.

 QXGA: 2048 or more

 UXGA: 1600 or more, less than 2048

 SXGA: 1280 or more, less than 1600

 XGA: 1024 or more, less than 1280

 SVGA: 800 or more, less than 1024

 [640]: 640 or more, less than 800

(The size is not displayed at under 640 pixels.)

Warning/alarm indications

If any one of the following indications lights up or flashes, please check the Camcorder.

Confirmatory indications

: A cassette with the accidental erasure prevention slider placed in the [SAVE] position is inserted.
No cassette is inserted.

: The built-in battery is low. -20-

: The warning/alarm indication appears when you record yourself. Turn the LCD monitor towards the viewfinder and check the warning/alarm indication.

: No card is inserted.



REMOTE :

An incorrect remote control mode has been selected. -23-

END: The tape came to the end during recording.

: The video heads are dirty. -60-

Textual indications

DEW DETECT/EJECT TAPE: Condensation has occurred. Take out the cassette and wait for a while. It takes some time until the cassette holder opens, but this is not a malfunction. -59-

LOW BATTERY: The battery is low. Recharge it. -14-

NO TAPE : No tape is inserted. -15-

TAPE END: The tape came to the end during recording.

CHECK REC TAB: You are attempting to record pictures on a tape with the accidental erasure prevention slider placed in the [SAVE] position.

You are attempting audio dubbing or digital dubbing on a tape with the accidental erasure prevention slider placed in the [SAVE] position.

CHECK REMOTE MODE: An incorrect remote control mode has been selected. This is only displayed at the first operation of the remote control after powering-on. -23-

WRONG TAPE FORMAT: You are attempting to play back a tape section that has been recorded with a different TV system. This cassette is incompatible.

UNPLAYABLE CARD: You are attempting to play back data not compatible with this Camcorder.

UNABLE TO A.DUB (LP RECORDED): Audio dubbing cannot be performed because the original recording was in LP mode.

UNABLE TO A.DUB: You are attempting to perform audio dubbing on a non-recorded tape.

COPY PROTECTED: Images cannot be recorded correctly because the medium is protected by a copy guard.

CARD ERROR: This card is not compatible with this Camcorder.
You are attempting to format a failed card. It displays, when you attempt to insert an incompatible card to Card Slot.

NO CARD: No card is inserted.

CARD FULL: Card does not have sufficient memory remaining.
Select Picture Playback Mode and delete unnecessary files.

NO DATA: There are no recorded files on the card.

FILE LOCKED: You are attempting to erase protected files.

CARD LOCKED: The write protection switch on the SD Memory Card is set to [LOCK].

NEED HEAD CLEANING: The video heads are dirty. -60-

PUSH THE RESET SWITCH: An irregularity in the equipment has been detected. Press the [RESET] button (-11-). This may solve the problem.

CHANGE MODE TO USE USB: The USB cable is connected to the Camcorder in Card Recording Mode.

DISCONNECT USB CABLE: You are attempting to turn the mode dial in PC mode with the USB cable connected to the Camcorder. You are attempting to record pictures on a tape/card with the USB cable connected to the Camcorder.

NO INK IN PRINTER: There is no ink. Check the connected printer.

NO PAPER IN PRINTER: There is no paper. Check the connected printer.

PRINTER ERROR: Check the connected printer.

CAN NOT USE USB:

You are connecting the USB cable with the DV cable connected.

CHANGE TO MANUAL MODE:

You are attempting to select the item on the [SCENE MODE] when the [AUTO/MANUAL/FOCUS] switch is set to [AUTO].

REVERSE THE LCD MONITOR:

At the time of 0 Lux MagicPix mode, when LCD monitor is not reversed, it displays. When the LCD monitor is rotated by 180° towards the lens, the brightness of the LCD monitor cannot be adjusted.

Functions cannot be used simultaneously

Some functions in the Camcorder are disabled or cannot be selected due to its specifications. The table below shows examples of functions restricted by conditions.

Functions	Conditions which disable the functions
<ul style="list-style-type: none"> ● Progressive 	<ul style="list-style-type: none"> ● When recording onto a tape and a card simultaneously ● When digital zoom (10× or higher) is used ● When the shutter speed is 1/750 or faster in Tape Recording Mode ● When the gain value is increased in Tape Recording Mode ● When the MagicPix function is used ● When the portrait mode of the scene mode is used in Tape Recording Mode
<ul style="list-style-type: none"> ● Digital zoom ● Fade 	<ul style="list-style-type: none"> ● When the Card Recording mode is used
<ul style="list-style-type: none"> ● Image stabilizer 	<ul style="list-style-type: none"> ● When the Card Recording mode is used ● When the MagicPix function is used
<ul style="list-style-type: none"> ● Backlight compensation 	<ul style="list-style-type: none"> ● When the iris/gain is set ● When the MagicPix function is used
<ul style="list-style-type: none"> ● Soft skin ● Tele-macro ● Recording check 	<ul style="list-style-type: none"> ● While recording to a tape
<ul style="list-style-type: none"> ● MagicPix 	<ul style="list-style-type: none"> ● While recording to a tape ● When the Card Recording mode is used
<ul style="list-style-type: none"> ● RapidFire ● Consecutive ● Photoshot 	<ul style="list-style-type: none"> ● When [PICTURE SIZE] is set to other than [640]
<ul style="list-style-type: none"> ● Zoom microphone ● Wind noise reduction 	<ul style="list-style-type: none"> ● An external microphone is used

● Scene mode	<ul style="list-style-type: none"> ● When setting the [AUTO/MANUAL/FOCUS] switch to [AUTO] ● When the MagicPix function is used
● Change of white balance	<ul style="list-style-type: none"> ● When digital zoom (10× or higher) is used ● When the MagicPix function is used ● When a menu is displayed
● Adjusting the shutter speed, iris/gain	<ul style="list-style-type: none"> ● When the MagicPix function is used ● When the scene mode is used
● Variable-speed search	<ul style="list-style-type: none"> ● During repeat playback
● Deleting files	<ul style="list-style-type: none"> ● When the write protect switch on the card is set to [LOCK] ● When the file is protected
● Formatting	<ul style="list-style-type: none"> ● When the write protect switch on the card is set to [LOCK]
● Audio dubbing	<ul style="list-style-type: none"> ● The section of a tape recorded in LP mode ● The blank section of a tape ● Sounds sent through the DV terminal

Before requesting repair (Problems and solutions)

Power/Body

1: The Camcorder power cannot be turned on.

- Is the battery fully charged? Use a fully charged battery.
- The battery protection circuit may have operated. Attach the battery to the AC adaptor for 5 to 10 seconds. If the Camcorder still cannot be used, the battery is faulty.

2: The Camcorder power is turned off automatically.

- If you set [POWER SAVE] to [5 MINUTES] and do not operate the Camcorder for about 5 continuous minutes, the power is automatically turned off for tape protection and power conservation. To resume recording, turn the [OFF/ON] switch to [OFF]. Then turn it to [ON] again. (-25-)

3: The Camcorder power does not stay on long enough.

- Is the battery low? If the remaining battery power indication is flashing or the message "LOW BATTERY" is displayed, the battery has run down. Charge the battery or attach a fully charged battery. (-14-)
- Has condensation occurred? When you carry the Camcorder from a cold place into a warm place, condensation may occur inside it. If so, the power is turned off automatically, disabling all operations except for taking cassettes out. Wait until the condensation indication disappears. (-59-)

4: Battery runs down quickly.

- Is the battery fully charged? Charge it with the AC adaptor. (-14-)
- Are you using the battery in an extremely cold place? The battery is affected by ambient temperature. In cold places, the operating time of the battery becomes shorter.
- Has the battery worn out? The battery has a limited life. If the operating time is still too short even after the battery is fully charged, depending on the usage, the battery has worn out and can no longer be used.

5: The Camcorder cannot be operated though powered up.

The Camcorder does not operate normally.

- Remove the cassette and then press the [RESET] button. (-59-) If normal conditions are not restored yet, turn off the power. Then, about 1 minute later, turn on the power again. (Conducting the above operation when the access lamp is on may destroy the data on the card.)

6: The cassette cannot be removed.

- Does the power lamp comes on when opening the cassette cover? (-17-) Make sure that the battery and the AC adaptor are properly connected. (-14-)
- Is the battery in use discharged? Charge the battery and remove the cassette.
- Close the cassette cover completely, and fully open it again. (-15-)

7: No operation other than cassette removal can be performed.

- Has condensation occurred? Wait until the condensation indication disappears. (-59-)

8: The remote control does not function.

- Has the button-type battery of the remote control run out? Replace it with a new button-type battery. (-22-)
- Is the setting on the remote control correct? If the setting on the remote control is not in agreement with the [REMOTE] setting on the Camcorder, the remote control does not operate. (-23-)

Recording**1: Recording does not start although power is supplied to the Camcorder and the cassette is correctly inserted.**

- Is the accidental erasure prevention slider on the cassette open? If it is open (set to [SAVE]), recording cannot be performed. (-16-)
- Is the tape wound to the end? Insert a new cassette.
- Is the recording mode set? When in the playback mode, recording cannot be performed. (-24-)
- Has condensation occurred? No operation other than cassette removal can be performed when condensation occurs. Wait until the condensation indication disappears. (-59-)
- Is the cassette cover open? If the cover is open, the Camcorder may not operate normally. Close the cassette cover. (-15-)

2: The screen has changed suddenly.

- Has the demonstration started? In the Tape Recording mode, if you set [DEMO MODE] >> [ON] without inserting a cassette and a card, the demonstration starts. For normal use, set this function to [OFF]. (-52-)

3: A cassette cannot be inserted.

- Has condensation occurred? Wait until the condensation indication disappears.

4: Auto focus function does not work.

- Is manual focus mode selected? If auto focus mode is selected, focus is automatically adjusted.
- There are some recording subjects and surroundings for which the auto focus does not operate correctly. (-64-) If so, use the manual focus mode to adjust the focus. (-35-)
- Is the MagicPix function set? When the MagicPix function is working, focusing shifts into the manual mode.

Indications**1: A sentence is displayed in red or yellow in the screen center.**

- Read the contents and respond to them. (-54-)

2: The time code becomes inaccurate.

- The time code indication counter may not be constant in the reversed slow-motion playback, but this is not a malfunction.

3: The remaining tape time indication disappears.

- The remaining tape time indication may disappear temporarily during frame-by-frame playback or other operation. If you continue ordinary recording or playback, the indication is restored.

4: The remaining tape time Indication does not match the actual remaining tape time.

- If scenes of less than 15 seconds are continuously recorded, the remaining tape time cannot be correctly displayed.
- In some cases, the remaining tape time indication may show remaining tape time that is 2 to 3 minutes shorter than the actual remaining tape time.

5: A function indication such as mode indication, remaining tape time indication, or time cord indication is not shown.

- If you set [SETUP] >> [DISPLAY] >> [OFF], indications other than the tape running condition, warning, and date indications disappear.

Playback (Sound)**1: Sound is not played back from the built-in speaker of the Camcorder or the headphones.**

- Is the volume too low? During playback, push the [-  /VOL+] lever to display the volume indication and adjust it. (-37-)

2: Different sounds are reproduced at the same time.

- Have you set [SETUP] >> [12bit AUDIO] >> [MIX]? If you set [AUDIO REC] >> [12bit] and dub audio to a recorded tape, you can hear the sound on recording and the sound dubbed at a later time. To hear the sounds separately, set to [ST1] or [ST2]. (-44-)
- Have you set [SETUP] >> [AUDIO OUT] >> [STEREO] and reproduced a picture containing the main sound and sub sound? Set to [L] to hear main sound, and set to [R] to hear the sub sound. (-51-)

3: Audio dubbing cannot be performed.

- Is the accidental erasure prevention slider on the cassette open? If it is open (set to [SAVE]), audio dubbing cannot be performed. (-16-)
- Are you attempting to edit a tape portion that was recorded in LP mode? LP mode does not allow audio dubbing. (-24-)

4: The original sound was erased when audio dubbing was performed.

- If you perform audio dubbing on a recording made in [16bit] mode, the original sound will be erased. If you wish to preserve the original sound, be sure to select [12bit] mode when recording.

5: Sounds cannot be played back.

- Although a cassette with no audio dubbing is being played, have you set [SETUP] >> [12bit AUDIO] >> [ST2]? To play back a cassette with no audio dubbing, set [12bit AUDIO] >> [ST1]. (-44-)
- Is the variable speed search function working? Press the [VAR. SEARCH] button on the remote control to cancel the variable speed search function. (-38-)

6: Noise is heard from the right headphone.

- Have you set [BASIC] >> [AV JACK] >> [OUT]? When you use the headphones, set to [OUT/Ω].

Playback (Pictures)**1: Mosaic-pattern noise appears on images during cue or review playback.**

- This phenomenon is characteristic of digital video systems. It is not a malfunction.

2: Horizontal stripes appear on images during cue and review playback.

- Horizontal stripes may appear depending on the scene, but this is not a malfunction.

3: Although the Camcorder is correctly connected to a TV, playback images cannot be seen.

- Have you selected video input on the TV? Please read the operating instructions of your TV and select the channel that matches the input terminals used for the connection.

4: Playback picture is not clear.

- Are the heads of the Camcorder dirty? If the heads are dirty, playback image cannot be clear. Clean the heads by using the head cleaner for digital video (optional). (-60-)
- If the terminal for the AV cable is soiled, noises may appear on the screen. Wipe the soil off the terminal with a soft cloth, and then connect the cable to the AV terminal.
- Is a picture containing a copyright protection signal (copy guard) being recorded? When a protected picture is played back by the Camcorder, mosaic-like patterns appear on the picture.

Card**1: Recorded pictures are not clear.**

- Have you set [BASIC] >> [PICT. QUALITY] >> [.]? If recording is done with it set to [..], pictures with fine details may include a mosaic-like pattern. Set [PICT. QUALITY] >> [..]. (-27-)

2: A file recorded on a card cannot be deleted.

- Is the file locked? Locked files cannot be deleted. (-41-)
- For the SD Memory Card, if its write protect switch is set to [LOCK], then deletion is disabled. (-17-)

3: Photoshot playback images do not look normal.

- The picture may be damaged. In order to prevent the loss of image data, backing up on a cassette or a personal computer is recommended.

4: Even if a card is formatted, it cannot be used.

- Either the Camcorder or the card may be damaged. Please consult a dealer.

5: During playback, [UNPLAYABLE CARD] is displayed.

- The image was either recorded in a different format, or data is damaged.

Others

1: The indication disappears, the screen is frozen, or no operation can be performed.

- Turn off the power to the Camcorder. If the power cannot be turned off, press the [RESET] button, or detach the battery or AC adaptor and then reattach it. After that, turn on the power again. If normal operation is still not restored, detach the power connected, and consult the dealer who you purchased the Camcorder from.

2: "PUSH THE RESET SWITCH" is displayed.

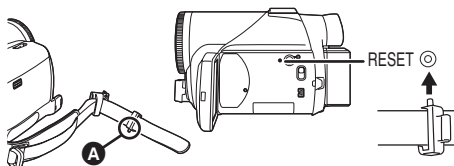

- An irregularity in the Camcorder has been automatically detected. Remove the cassette or the card for data protection and then press the [RESET] button with the boss **A**. The Camcorder will be activated.



- If you do not press the [RESET] button, the power to the Camcorder is turned off automatically about 1 minute later.
 - Even after you press the [RESET] button, the indication may still appear repeatedly. If so, the Camcorder needs repair. Detach the power connected, and consult the dealer who you purchased the Camcorder from. Do not attempt to repair the unit by yourself.
- ### 3: When the USB cable is disconnected, an error message will appear on PC.
- To disconnect the USB cable safely, double-click the  icon in the task tray and follow the instructions on the screen.

Cautions for Use

■ About condensation

If you turn the Camcorder on when condensation occurs on the head or the tape, condensation Indication  (yellow or red) is displayed on the viewfinder or the LCD monitor and the messages  [DEW DETECT] or  [EJECT TAPE] (only when the tape is inserted) appear. If so, follow the procedure below.

in yellow:

Dew is slightly adhering on the head or the tape.

in red:

Dew is adhering on the head or the tape.

1 Remove the tape if it is inserted.

- It takes about 20 seconds to open the cassette holder. This is not a malfunction.

2 Leave the Camcorder with the cassette cover closed to cool or warm it to the ambient temperature.

When in yellow

- You cannot use the Tape Recording/Playback Mode. Leave the Camcorder for about 30 minutes.
- However, you can use the Card Recording Mode or Picture Playback Mode when a cassette is not inserted.

When in red

- The power Lamp blinks for about 1 minute and then the Camcorder automatically turns off. Leave it for about 2 to 3 hours.

3 Turn the Camcorder on again, set it to the Tape Recording/Playback Mode and then check if the condensation indication disappears.

Especially in cold areas, moisture may be frozen. If so, it may take more time before the condensation indication disappears.

Watch for condensation even before the condensation Indication is displayed.

- The condensation indication may not appear depending on circumstances. When condensation occurs on the lens or the Camcorder, it may also occur on the head and the tape. Do not open the cassette cover.

When the lens is fogged:

Set the [OFF/ON] switch to [OFF] and leave the Camcorder in this condition for about 1 hour.

When the lens temperature becomes close to the ambient temperature, the fogging disappears naturally.

■ About dirty heads

If video heads (the parts that closely contact with the tape) become dirty, normal recording and playback are not properly performed.

Clean the heads with the digital video head cleaner.

- Insert the head cleaner into the Camcorder, set it to the Tape Playback Mode, and play it back for about 10 to 20 seconds. (If you do not stop the playback, it automatically stops about 30 seconds later.)

- We recommend cleaning the heads periodically.

If the heads become dirty, "NEED HEAD CLEANING" appears during recording. During playback, moreover, the following symptoms appear.

- Mosaic-like noise appears partially or the sound is interrupted.
- Black or blue mosaic-like horizontal stripes appear.

When normal playback cannot be performed even after the head cleaning

One possible cause is that normal recording could not be performed because the heads were dirty at the time of recording. Clean the heads, and perform recording and playback again. If normal playback can be performed, the heads are clean. Before an important recording, be sure to conduct a test recording to make sure that normal recording can be performed.

- If the heads become dirty soon after cleaning, the problem may be the tape. If so, try another cassette.
- During playback, the picture or sound may be interrupted momentarily, but this is not a malfunction of the Camcorder. (One possible cause is that the playback is interrupted by dirt or dust that momentarily adheres to the heads.)

■ About the Camcorder

- When the Camcorder is used for a long time, the Camcorder body becomes warm, but this is not a malfunction.

Keep the Camcorder away from magnetized equipment such as a cellular phones, microwave ovens, TVs, and video game equipment.

- If you use the Camcorder on or near a TV, images or sounds may be disturbed due to electromagnetic wave radiation.
- Recordings on the tape may be damaged, or images may be distorted, by strong magnetic fields created by speakers or large motors.
- Electromagnetic wave radiation generated by digital circuits including microprocessor may adversely affect the Camcorder, causing the disturbance of images and sounds.
- If the Camcorder is affected by such equipment and does not function properly, turn off the Camcorder power and detach the battery or AC adaptor. Then, connect the battery or AC adaptor again and turn on the Camcorder power.

Do not use your Camcorder near radio transmitters or high-voltage cables.

- If you record pictures near radio transmitters or high-voltage cables, recorded images or sounds may be adversely affected.

Do not spray insecticides or volatile chemicals onto the Camcorder.

- If the Camcorder is sprayed with such chemicals, the Camcorder body may become deformed and the surface finish may peel off.
- Do not keep rubber or plastic products in contact with the Camcorder for a long time.

When you use your Camcorder in a sandy or dusty place such as on a beach, do not let sand or fine dust get into the body and terminals of the Camcorder. Also, protect the Camcorder from getting wet.

- Sand or dust may damage the Camcorder or cassette. (Care should be taken when inserting and removing a cassette.)
- If sea water splashes onto the Camcorder, wet a soft cloth with tap water, wring it well, and use it to wipe the Camcorder body carefully. Then, wipe it again thoroughly with a soft dry cloth.

While carrying the Camcorder, do not drop or bump it.

- A strong impact on the Camcorder may break its housing, causing it to malfunction.

Do not use benzene, paint thinner or alcohol for cleaning the Camcorder.

- Before cleaning, detach the battery or pull out the AC mains lead from the AC mains socket.
- The Camcorder body may be discoloured and the surface finish may peel off.
- Wipe the Camcorder with a soft dry cloth to remove dust and fingerprints. To remove stubborn stains, wring well a cloth that is soaked in a neutral detergent diluted with water and wipe the Camcorder with it. Afterwards, wipe it with a dry cloth.
- When you use a chemical dust cloth, follow the instructions.

Do not use this Camcorder for surveillance purposes or other business use.

- If you use the Camcorder for a long time, the internal temperature increases and, consequently, this may cause malfunction.
- This Camcorder is not intended for business use.

■ About the battery

The battery used in the Camcorder is a rechargeable lithium ion battery. This battery is susceptible to temperature and humidity, and the effect of temperature increases with increasing or decreasing temperature. In the low temperature range, the fully charged indication may not appear, or the low battery indication may appear about 5 minutes after the start of use. At high temperature, moreover, the protection function may work, disabling use of the Camcorder.

Be sure to detach the battery after use

- If the battery is left attached to the Camcorder, a minute amount of current is consumed even when the Camcorder power is [OFF]. If the battery is left attached to the Camcorder for a long time, over-discharge takes place. The battery may become unusable after it is charged.

Prepare spare batteries when going out for recording.

- Prepare batteries appropriate to 3 to 4 times the period during you want to record pictures in. In cold places such as a ski resort, the period during which you can record pictures is shortened.
- When you travel, do not forget to bring an AC adaptor so that you can recharge the batteries at your destination.

If you drop the battery accidentally, check to see if the terminals are deformed.

- Attaching a deformed battery to the Camcorder or AC adaptor may damage the Camcorder or AC adaptor.

After use, be sure to take the cassette out and detach the battery from the Camcorder or pull out the AC mains lead from AC mains socket.

- The battery should be stored in a cool place free from humidity, with as constant temperature as possible. (Recommended temperature: 59°F to 77°F (15°C to 25°C), Recommended humidity: 40% to 60%)
- Extremely high temperatures or low temperatures will shorten the life of the battery.
- If the battery is kept in a high-temperature, high-humidity, or oily-smoky places, the terminals may rust and cause malfunctions.
- To store the battery for a long period of time, we recommend you charge it once every year and store it again after you have completely used up the charged capacity.
- Dust and other matter attached to the battery terminals should be removed.

Do not throw old battery into fire.

- Heating a battery or throwing it into a fire may result in an explosion.
- If the operating time is very short even after the battery has been recharged, the battery has worn out. Please purchase a new battery.

■ About the AC adaptor

- If the battery is warm, charging requires more time than normal.
- If the temperature of the battery is extremely high or extremely low, the [CHARGE] lamp may continue flashing, and the battery may not be charged. After the battery temperature has decreased or increased sufficiently, recharging starts automatically. So, wait for a while. If the lamp still continues flashing even after the recharging, the battery or AC adaptor may be faulty. If so, please contact a dealer.
- If you use the AC adaptor near a radio, radio reception may be disturbed. Keep the AC adaptor 3 feet (1 m) or more away from radio.
- When using the AC adaptor, it may generate whirring sounds. However, this is normal.
- After use, be sure to pull out the AC mains lead from the AC mains socket. (If they are left connected, a minute amount of current is consumed.)
- Always keep the electrodes of the AC adaptor and battery clean.

■ About the cassette

Never place the cassette in a high temperature place.

- The tape may be damaged, producing mosaic-like noise at the time of playback.

When storing the cassette after use, be sure to rewind the tape to the beginning and take it out.

- If the cassette is left for more than 6 months (depending on the storage condition) in the Camcorder or stopped midway, the tape may sag and be damaged.
- Once every 6 months, wind the tape to the end and then rewind it to the beginning. If the cassette is left for 1 year or longer without winding or rewinding, the tape may be deformed by expansion or shrinkage attributable to temperature and humidity. The wound tape may stick to itself.
- Dust, direct sunlight (ultraviolet rays), and humidity may damage the tape. Such usage may cause damage to the Camcorder and the heads.
- After use, be sure to rewind the tape to the beginning, put the cassette in the case to protect it from dust, and store it upright.

Keep the cassette away from strong magnetism.

- Objects using magnets such as magnetic necklaces and toys having a magnetic force that is stronger than expected, may erase the contents of a recording or may increase noise.

■ About the card

When inserting or removing the card, always set the [OFF/ON] switch to [OFF].

When the access lamp is illuminated (During access to the card), do not open the card slot cover to pull out the card, turn off the power, or cause any vibrations or impact.

Do not leave the card in places where there is high temperature or direct sunlight, or where electromagnetic waves or static electricity are easily generated. Moreover, do not fold or drop the card.

- The card may break or the contents of the card may be destroyed or erased.

After use, be sure to remove the card from the Camcorder for storage.

- After use, or when storing or carrying the card, put it in the storage case.
- Do not allow dust, water, or foreign substances to adhere to the terminals on the back of the card. Moreover, do not touch the terminals with your hand.
- Keep the Memory Card out of reach of children to prevent swallowing.

■ Folder structure of the card

The folder structure of the card formatted by the Camcorder will be displayed on the PC as the illustration below.

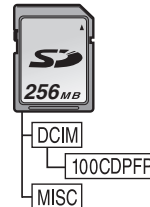

- Up to 999 pictures can be recorded on 100CDPFP folder etc.
- Files with the DPOF settings can be recorded on MISC folder.

LCD monitor/Viewfinder

LCD monitor

- When the LCD monitor gets dirty, wipe it with a dry soft cloth.
- In a place with drastic temperature changes, condensation may form on the LCD monitor. Wipe it with soft dry cloth.
- If your Camcorder is extremely cold, the LCD monitor is slightly darker than usual immediately after you turn the power on. However, as the internal temperature increases, it goes back to normal brightness.

Extremely high precision technology is employed to produce the LCD monitor screen featuring a total of approximately 113,000 pixels. The result is more than 99.99% effective pixels with a mere 0.01% of the pixels inactive or always lit. However, this is not a malfunction and does not affect the recorded picture.

Viewfinder

Extremely high precision technology is employed to produce the viewfinder screen featuring a total of approximately 113,000 pixels. The result is more than 99.99% effective pixels with a mere 0.01% of the pixels inactive or always lit. However, this is not a malfunction and does not affect the recorded picture.

Periodical check-ups

- To maintain the highest image quality, we recommend replacing worn parts such as heads after approx. 1000 hours of use. (This, however, depends on operating conditions including temperature, humidity and dust.)

Explanation of terms

Automatic white balance

White balance adjustment recognizes the color of light and adjusts so the white color will become a pure white. The Camcorder determines the hue of light that comes through the lens and white balance sensor, thereby judging the recording condition, and selects the closest hue setting. This is called automatic white balance adjustment. However, since the Camcorder only stores white color information under several light sources, automatic white balance adjustment does not function normally under the other light sources.

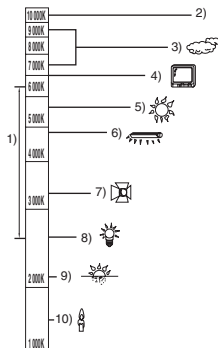

Outside of the effective range of automatic white balance adjustment, the image will become reddish or bluish. Even within the effective range of automatic white balance adjustment, the automatic white balance adjustment may not function properly if there is more than one light source. For light outside the functional auto white balance adjustment range, use the manual white balance adjustment mode.

- 1) The effective range of automatic white balance adjustment on this Camcorder
- 2) Blue sky
- 3) Cloudy sky (rain)
- 4) TV screen
- 5) Sunlight
- 6) White fluorescent lamp
- 7) Halogen light bulb
- 8) Incandescent light bulb
- 9) Sunrise or sunset
- 10) Candlelight

■ White balance

The image recorded by the Camcorder may become bluish or reddish under the influence of light sources. To avoid such phenomena, adjust the white balance.

White balance adjustment determines the white color under different light sources. By recognizing which is the white color under sunlight and which is the white color under a fluorescent lamp, the Camcorder can adjust the balance among the other colors.

Since white color is the reference of all colors (light), the Camcorder can record pictures in a natural hue if it can recognize the reference white color.

■ Auto focus

Auto focus automatically moves the focusing lens forward and backward inside the Camcorder to bring the subject into focus.

Auto focus has the following characteristics.

- Adjusts so that the vertical lines of a subject are seen more clearly.
- Attempts to bring an object with higher contrast into focus.
- Focuses on the screen center only.

Due to these characteristics, auto focus does not work correctly in the following situations. Record pictures in the manual focus mode.

Recording a subject with one end located closer to the Camcorder and the other end farther away from it

- As auto focus adjusts at the center of an image, it may be impossible to focus on a subject that is located in both the foreground and background.

Recording a subject behind dirty or dusty glass

- The subject behind the glass will not be focused because the focus is on the dirty glass.

Recording a subject that is surrounded by objects with glossy surfaces or by highly reflective objects

- The recording subject may become blurry because the Camcorder focuses on the objects with glossy surfaces or on highly reflective objects.

Recording a subject in dark surroundings

- The Camcorder cannot focus correctly because the light information that comes through the lens decreases considerably.

Recording a fast-moving subject

- As the focus lens-inside moves mechanically, it cannot keep up with a fast-moving subject.

Recording a subject with little contrast

- A subject with little contrast, such as a white wall, may become blurry because the Camcorder achieves focus based upon the vertical lines of an image.

Specifications

Digital Video Camcorder

Information for your safety

Power source:

DC 7.9/7.2 V

Power consumption:

Recording
5.0 W

Recording format:

Mini DV (Consumer-use digital video SD format)

Tape used:

6.35 mm digital video tape

Recording/playback time:

SP: 80 min.; LP: 120 min. (with DVM80)

Video
Recording system:

Digital component

Television system:

EIA Standard: 525 lines, 60 fields NTSC color signal

Audio
Recording system:

PCM digital recording
16 bit (48 kHz/2ch), 12 bit (32 kHz/4ch)

Image sensor:

1/6-inch 3CCD image sensor
(Effective pixels: moving picture/290 K×3, still
picture/280 K×3, Total: 460 K×3)

Lens:

Auto Iris, F1.8, Focal length; 2.45–24.5 mm, Macro
(Full range AF)

Filter diameter:

37 mm

Zoom:

10:1 Power zoom

Monitor:

2.5-inch LCD

Viewfinder:

Color electronic viewfinder

Microphone:

Stereo (with a zoom function)

Speaker:

1 round speaker \varnothing 20 mm

Standard illumination:

1,400 lx

Minimum required illumination:

1 lx (MagicPix Mode)

Video output level:

1.0 Vp-p, 75 ohm

S-Video output level:

Y Output: 1.0 Vp-p, 75 ohm
C Output: 0.286 Vp-p, 75 ohm

Audio output level (Line):

316 mV, 600 ohm

Mic input:

Mic sensitivity -50 dB (0 dB=1 V/Pa, 1 kHz) (Stereo
mini jack)

USB:

Card reader/writer function, USB 2.0 compliant
(Full Speed)
No copyright protection support
PictBridge-compliant

Digital interface:

DV input/output terminal (IEEE1394, 4-pin)

Dimensions:

Approx. 3.0 inch (W) × 3.1 inch (H) × 4.8 inch (D)
Approx. 76 mm (W) × 77 mm (H) × 120 mm (D)

Weight:

Approx. 0.93 lbs (420 g)
(without battery, DV cassette and lens cap)

Operating temperature:

32°F–104°F (0°C–40°C)

Operating humidity:

10%–80%

Card memory functions
Recording media:

SD Memory Card (32 MB/64 MB/128 MB/256 MB/
512 MB/1 GB)

Still picture recording file format:

JPEG (Design rule for Camera File system, based
on Exif 2.2 standard), DPOF corresponding

Still picture size:

Mega pixel recording:
1280×960
VGA recording: 640×480

AC adaptor

Information for your safety

Power source:

AC 110–240 V, 50/60 Hz

Power consumption:

19 W

DC output:

DC 7.9 V, 1.4 A (Camcorder operation)
DC 8.4 V, 0.65 A (Battery charging)

Dimensions:





2.40 inch (W) × 1.26 inch (H) × 3.58 inch (D)
61 mm (W) × 32 mm (H) × 91 mm (D)

Weight:

Approx. 0.24 lbs. (110 g)









Weight and dimensions are approximate values.
Specifications may change without prior notice.

Maximum number of still pictures recordable on an SD Memory Card (optional)

PICTURE SIZE	[640]		[1280]	
				
32 MB	220	440	47	76
64 MB	440	880	98	158
128 MB	880	1760	187	302
256 MB	1760	3520	390	628
512 MB	3520	7040	774	1246
1 GB	7040	14080	1550	2495

- The numbers shown in the table are approximations.
- These figures vary depending on the subject being photographed.

Camcorder Accessory System

Accessory#	Figure	Description
PV-DAC14		AC adaptor with AC Cable and DC Cables
*CGR-DU06A/1B		640 mAh/Rechargeable Lithium Ion Battery Pack
*CGA-DU12A/1B		1150 mAh/Rechargeable Lithium Ion Battery Pack
*CGA-DU21A/1B		2040 mAh/Rechargeable Lithium Ion Battery Pack
PV-DDC9 (For USA) PV-DDC9-K (For Canada)		DV Interface Cable (i.LINK) (4-pin to 4-pin)
RP-SDH01GU1A RP-SDH512U1A RP-SDH256U1A/W RP-SD128BU1A/W RP-SD064BPPA/W RP-SD032BPPA		1 GB SD Memory Card 512 MB SD Memory Card 256 MB SD Memory Card 128 MB SD Memory Card 64 MB SD Memory Card 32 MB SD Memory Card
BN-SDCAPE/1B (For USA) BN-SDCAPU/1B (For Canada)		USB Reader/Writer for SD Memory Card
BN-SDABPE/1B (For USA) BN-SDABPU/1B (For Canada)		SD PCMCIA Adaptor
PV-HB002 (USA only)		Carrying Case

*Please refer to page -15-, concerning the battery charging time and available recording time.

***NOTE: Accessories and/or model numbers may vary by country. Please consult your local dealer.**

Camcorder Accessory Order Form (For USA Customers)

Please photocopy this form when placing an order.

1. Palmcorder Model # _____

2. Items Ordered

Accessory #	Description	Price Each	Quantity	Total Price
Subtotal				
Your State & Local Sales Tax				
Shipping & Handling				6.95
Total Enclosed				

3. Method of payment (check one)

- Check of Money Order enclosed (NO C.O.D.SHIPMENTS)
- VISA Credit Card # _____
- MasterCard Expiration Date _____
- Discover Customer Signature _____

Make Check or Money Order Payable to: PANASONIC ACCESSORIES

(Please do not send cash)

4. Shipping information (UPS delivery requires complete street address)

Ship To:

Mr.

Mrs.

Ms.

First _____ Last _____

Phone#:

Day () _____

Street Address _____

Night () _____

City _____ State _____ Zip _____

TO OBTAIN ANY OF OUR PALMCORDER ACCESSORIES YOU CAN DO ANY OF THE FOLLOWING:

VISIT YOUR LOCAL PANASONIC DEALER

OR

CALL PANASONIC'S ACCESSORY ORDER LINE AT 1-800-332-5368

[6 AM-5 PM M-F, 6 AM-10:30 AM SAT, PACIFIC TIME]

OR

MAIL THIS ORDER TO: PANASONIC SERVICES COMPANY ACCESSORY ORDER OFFICE
20421 84th Avenue South Kent, WA. 98032

In CANADA, please contact your local Panasonic dealer for more information on Accessories.

Request for Service Notice (USA Only)

Please photocopy this form when making a request for service notice, in the unlikely event this product needs service.

Request for Service Notice:

- Please include your **proof of purchase.**
(Failure to do so will delay your repair.)
 - To further speed your repair, please provide an explanation of what is wrong with the unit and any symptom it is exhibiting.
-
-
-

Mail this completed form and your Proof of Purchase along with your unit to:
Panasonic Services Company
1705 N. Randall Road
Elgin, IL. 60123-7847
Attn: Camcorder Repair

Limited Warranty (For USA Customers)

PANASONIC CONSUMER ELECTRONICS COMPANY, DIVISION OF PANASONIC CORPORATION OF NORTH AMERICA
One Panasonic Way, Secaucus, New Jersey 07094

PANASONIC PUERTO RICO, INC.
Ave. 65 de Infantería, Km. 9.5 San Gabriel Industrial Park,
Carolina, Puerto Rico 00985

**Panasonic/Quasar Video Products
Limited Warranty**

Limited Warranty Coverage

If your product does not work properly because of a defect in materials or workmanship, Panasonic Consumer Electronics Company or Panasonic Puerto Rico, Inc. (collectively referred to as "the warrantor") will, for the length of the period indicated on the chart below, which starts with the date of original purchase ("warranty period"), at its option either (a) repair your product with new or refurbished parts, or (b) replace it with a new or a refurbished product. The decision to repair or replace will be made by the warrantor.

Product	Parts	Labor	Service	Contact Number
Camcorder	One (1) Year (except CCD Image Sensor) CCD Image Sensor - 6 (Six) Months	Ninety (90) Days Ninety (90) Days	Carry-In or Mail-In	1-800-211-PANA(7262)
DVD/VCR Deck, A/V Mixer	One (1) Year	Ninety (90) Days	Carry-In or Mail-In	1-800-211-PANA(7262)
TV/VCR, TV/DVD, TV/DVD/VCR Combination	One (1) Year (except CRT) CRT - Two (2) Years	Ninety (90) Days Ninety (90) Days	Carry-In: 21" CRT and Smaller In-Home or Carry-In: 22" CRT and Larger	1-800-211-PANA(7262)
TV/HDR Combination	One (1) Year (except CRT) CRT - Two (2) Years	Ninety (90) Days Ninety (90) Days	In-Home or Carry-In	1-888-843-9788
Rechargeable Batteries (in exchange for defective item)	Ten (10) Days	Not Applicable	Carry-In or Mail-In	1-800-211-PANA(7262)
Tape (in exchange for defective item)	Five (5) Days	Not Applicable	Carry-In or Mail-In	1-800-211-PANA(7262)
Memory Cards (in exchange for defective item)	Ninety (90) Days	Not Applicable	Carry-In or Mail-In	1-800-211-PANA(7262)

During the "Labor" warranty period there will be no charge for labor. During the "Parts" warranty period, there will be no charge for parts. You must carry-in or mail-in your product or arrange for in-home service, as applicable, during the warranty period. If non-rechargeable batteries are included, they are not warranted. This warranty only applies to products purchased and serviced in the United States or Puerto Rico. This warranty is extended only to the original purchaser of a new product which was not sold "as is". A purchase receipt or other proof of the original purchase date is required for warranty service.

Carry-In, Mail-in or In-Home Service

For Carry-In, Mail-In or In-Home Service (as applicable) in the United States call toll free contact number listed above or visit Panasonic Web Site: <http://www.panasonic.com>

For assistance in Puerto Rico call Panasonic Puerto Rico, Inc. (787)-750-4300 or fax (787)-768-2910.

In-Home service, if applicable, requires clear, complete and easy access to the product by the authorized servicer and does not include removal or re-installation of an installed product. It is possible that certain in-home repairs will not be completed in-home, but will require that the product, or parts of the product, be removed for shop diagnosis and/or repair and then returned.

Limited Warranty Limits And Exclusions

This warranty ONLY COVERS failures due to defects in materials or workmanship, and DOES NOT COVER normal wear and tear or cosmetic damage, nor does it cover markings or retained images on the picture tube resulting from viewing fixed images (including, among other things, letterbox pictures on standard 4:3 screen TV's, or non-expanded standard 4:3 pictures on wide screen TV's, or onscreen data in a stationary and fixed location). The warranty ALSO DOES NOT COVER damages which occurred in shipment, or failures which are caused by products not supplied by the warrantor, or failures which result from accidents, misuse, abuse, neglect, mishandling, misapplication, alteration, faulty installation, set-up adjustments, misadjustment of consumer controls, improper maintenance, power line surge, lightning damage, modification, or commercial use (such as in a hotel, office, restaurant, or other business), rental use of the product, service by anyone other than a Factory Servicer or other Authorized Servicer, or damage that is attributable to acts of God.

THERE ARE NO EXPRESS WARRANTIES EXCEPT AS LISTED UNDER "LIMITED WARRANTY COVERAGE". THE WARRANTOR IS NOT LIABLE FOR INCIDENTAL OR CONSEQUENTIAL DAMAGES RESULTING FROM THE USE OF THIS PRODUCT, OR ARISING OUT OF ANY BREACH OF THIS WARRANTY.

(As examples, this excludes damages for lost time, cost of having someone remove or re-install an installed unit if applicable, or travel to and from the servicer, loss of media or images, data or other memory or recorded content. The items listed are not exclusive, but are for illustration only.)

ALL EXPRESS AND IMPLIED WARRANTIES, INCLUDING THE WARRANTY OF MERCHANTABILITY, ARE LIMITED TO THE PERIOD OF THE LIMITED WARRANTY.

Some states do not allow the exclusion or limitation of incidental or consequential damages, or limitations on how long an implied warranty lasts, so the exclusions may not apply to you. This warranty gives you specific legal rights and you may also have other rights which vary from state to state. If a problem with this product develops during or after the warranty period, you may contact your dealer or Servicer. If the problem is not handled to your satisfaction, then write to the warrantor's Consumer Affairs Department at the addresses listed for the warrantor.

PARTS AND SERVICE (INCLUDING COST OF AN IN-HOME SERVICE CALL, WHERE APPLICABLE) WHICH ARE NOT COVERED BY THIS LIMITED WARRANTY ARE YOUR RESPONSIBILITY.

Customer Services Directory

Service in Canada: As per Sevicenter listed in Canadian warranty information on page -72-.

Obtain Product Information and Operating Assistance; locate your nearest Dealer or Servicenter; purchase Parts and Accessories; or make Customer Service and Literature requests by visiting our Web Site at:

<http://www.panasonic.com/consumersupport>

or, contact us via the web at:

<http://www.panasonic.com/contactinfo>

You may also contact us directly at:

1-800-211-PANA (7262),

Monday-Friday 9 am-9 pm; Saturday-Sunday 10 am-7 pm, EST

For hearing or speech impaired TTY users, TTY : 1-877-833-8855

Accessory Purchases

Purchase Parts, Accessories and Instruction Books online for all Panasonic Products by visiting our Web Site at:

<http://www.pasc.panasonic.com>

or, send your request by E-mail to:

npcparts@us.panasonic.com

You may also contact us directly at:

1-800-332-5368 (Phone) 1-800-237-9080 (Fax Only) (Monday – Friday 9 am to 8 pm, EST.)

Panasonic Services Company

20421 84th Avenue South,

Kent, WA 98032

(We Accept Visa, MasterCard, Discover Card, American Express, and Personal Checks)

For hearing or speech impaired TTY users, TTY : 1-866-605-1277

Product Repairs

Centralized Factory Servicenter

MAIL TO:

Panasonic Services Company

1705 N. Randall Road,

Elgin, IL 60123-7847

Attention: Camcorder Repair

Please carefully pack and ship, prepaid and insured, to the Elgin Centralized Factory Servicenter Customer's in Puerto Rico, please ship or carry in to location below ("Service in Puerto Rico").

Service in Puerto Rico

Panasonic Puerto Rico, Inc.

Ave. 65 de Infantería, Km. 9.5, San Gabriel Industrial Park,

Carolina, Puerto Rico 00985

Phone (787)750-4300, Fax (787)768-2910

As of November 2004

Warranty (For Canadian Customers)**Panasonic Canada Inc.**

5770 Ambler Drive, Mississauga, Ontario L4W 2T3

PANASONIC PRODUCT – LIMITED WARRANTY

Panasonic Canada Inc. warrants this product to be free from defects in material and workmanship and agrees to remedy any such defect for a period as stated below from the date of original purchase.

Camcorder Product – One (1) year, parts and labour**LIMITATIONS AND EXCLUSIONS**

This warranty does not apply to products purchased outside Canada or to any product which has been improperly installed, subjected to usage for which the product was not designed, misused or abused, damaged during shipping, or which has been altered or repaired in any way that affects the reliability or detracts from the performance, nor does it cover any product which is used commercially. Dry cell batteries are also excluded from coverage under this warranty.

This warranty is extended to the original end user purchaser only. A purchase receipt or other proof of date of original purchase is required before warranty service is performed.

THIS EXPRESS, LIMITED WARRANTY IS IN LIEU OF ALL OTHER WARRANTIES, EXPRESS OR IMPLIED, INCLUDING ANY IMPLIED WARRANTIES OF MERCHANTABILITY AND FITNESS FOR A PARTICULAR PURPOSE.

IN NO EVENT WILL PANASONIC CANADA INC. BE LIABLE FOR ANY SPECIAL, INDIRECT OR CONSEQUENTIAL DAMAGES.

In certain instances, some jurisdictions do not allow the exclusion or limitation of incidental or consequential damages, or the exclusion of implied warranties, so the above limitations and exclusions may not be applicable.

WARRANTY SERVICE

For product operation and information assistance, please contact your Dealer or our Customer Care Centre at:

Telephone #: (905) 624-5505

Fax #: (905) 238-2360

Web: www.panasonic.ca

For product repairs, please contact one of the following:

- Your Dealer who will inform you of an authorized Servicentre nearest you.
- Our Customer Care Centre at (905) 624-5505 or www.panasonic.ca
- A Panasonic Factory Servicentre listed below:

Richmond, British Columbia

Panasonic Canada Inc.

12111 Riverside Way

Richmond, BC

V6W 1K8

Tel: (604) 278-4211

Fax: (604) 278-5627

Calgary, Alberta

Panasonic Canada Inc.

6835-8th St. N. E.

Calgary, AB

T2E 7H7

Tel: (403) 295-3955

Fax: (403) 274-5493

Mississauga, Ontario

Panasonic Canada Inc.

5770 Ambler Dr.

Mississauga, ON

L4W 2T3

Tel: (905) 624-8447

Fax: (905) 238-2418

Lachine, Québec

Panasonic Canada Inc.

3075, rue Louis A. Amos

Lachine, QC

H8T 1C4

Tel: (514) 633-8684

Fax: (514) 633-8020

IF YOU SHIP THE PRODUCT TO A SERVICENTRE

Carefully pack and send prepaid, adequately insured and preferably in the original carton. Include details of the defect claimed, and proof of date of original purchase.

Index

■ Numerics	
0 Lux MagicPix function	30
■ A	
AC Adaptor	14, 61
Aperture	36
Audio Dubbing	44
■ B	
Backlight Compensation	29
Black Balance	35
Blank Search	26
■ C	
Camcorder Accessory Order Form	68
Card Playback	39
Charging the Battery	14
Condensation	59
Customer Services Directory	71
■ D	
Date/Time Setting	20
Digital Dubbing	43
Digital Zoom	28
DPOF Setting	41
Dubbing	42
■ E	
Erasure Prevention Slider	16
■ F	
Fade	31
Formatting	41
Frame-by-frame playback	37
■ I	
Image stabilizer function	32
■ L	
LCD Monitor	13, 63
Limited Warranty (Canada)	72
Limited Warranty (USA)	70
Low Light Mode	33
■ M	
MagicPix Function	30
Manual Focus	35
Mode Dial	17
■ P	
Photoshot	26
PictBridge	45
Portrait Mode	33
■ Q	
Quick Start	29
■ R	
RapidFire Consecutive Photoshot	33
Recording Check	26
Recording Speed	24
Remaining Tape Time	53
Remote Control	22
Repeat Playback	37
Request for Service Notice (USA Only)	69
■ S	
Scene mode	33
Self-Recording	28
Self-timer Recording	32
Shutter Speed	36
Slow Motion Playback	37
Soft Skin Mode	30
Sound Volume	37
SP/LP Mode	24
Sports Mode	33
Spotlight Mode	33
Surf & Snow Mode	33
■ T	
Tele-Macro Function	31
■ V	
Variable Speed Search	38
Video Head Clogging	60
Viewfinder	13, 63
■ W	
White Balance	34
Wind noise reduction function	31
■ Z	
Zoom	27
Zoom Microphone	28

Spanish Quick Use Guide/ Guía española para el uso rápido

■ Carga de la batería

- 1 Conecte el cable eléctrico de CA al adaptador de CA y a la toma de la red de CA.
- 2 Meta la batería en el respectivo soporte alineando la marca, luego encájela.

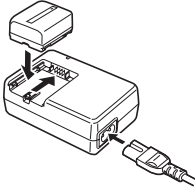

■ Montaje de la batería

Empuje la batería contra el porta batería y hágala deslizar hasta que dispare.

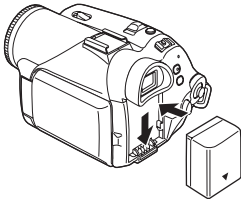

■ Insertar/quitar un cassette

- 1 Haga deslizar la palanca [OPEN/EJECT] y abra la tapa del cassette.

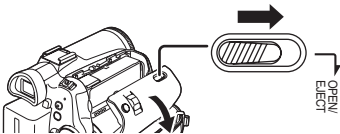

- 2 Una vez que el compartimiento del cassette esté abierto, inserte/quite el cassette.

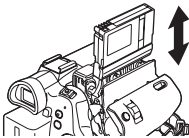

- 3 Apriete la marca [PUSH] ❶ a fin de cerrar el compartimiento del cassette.

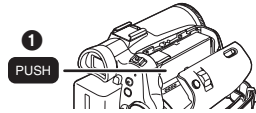

- 4 Sólo cierre la tapa del cassette después de que el respectivo compartimiento esté cabalmente alojado.

■ Insertar/quitar una tarjeta

- 1 Abra el monitor LCD, luego abra la tapa de la ranura de la tarjeta.



- 2 Inserte/quite la tarjeta en/de la ranura.

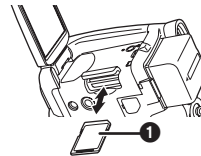

- Cuando inserta una tarjeta, con su lado etiquetado vuelto ❶ hacia Ud., la apriete derecha de un solo golpe hasta que tope.
- Cuando quita la tarjeta, abra la tapa de la respectiva ranura, apriete en el medio de la tarjeta y tírela fuera derecha.

- 3 Cierre firmemente la tapa de la ranura de la tarjeta.

■ Cómo activar la alimentación

- 1 Mientras que oprime el botón ❶, ponga el interruptor [OFF/ON] en [ON].

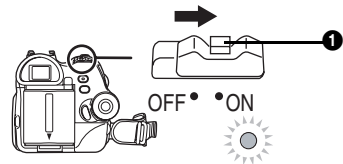

■ Cómo apagar la alimentación

- 1 Mientras que oprime el botón ①, ponga el interruptor [OFF/ON] en [OFF].

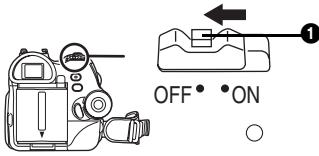

■ Grabación en una cinta

- Ajuste al modo de grabación de cinta.

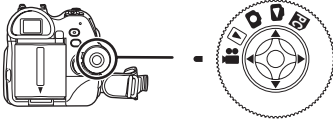

- 1 Oprima el botón de inicio/parada de la grabación para empezar a grabar.



- 2 Oprima de nuevo el botón de inicio/parada de la grabación para detener brevemente la grabación.



■ Grabación de imágenes fijas en una tarjeta (Photoshot)

- Ajuste al modo de grabación de tarjeta.

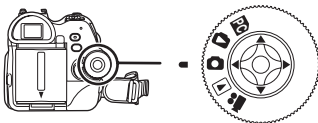

- 1 Oprima el botón [PHOTO SHOT].



■ Reproducción de la cinta

- Ajuste al modo de reproducción de cinta.

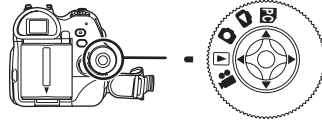

- 1 Actúe en la palanca de mando.



- ▶/||: Reproducción/Pausa
- ◀◀: Rebobinado/Localización regresiva (Vuelve para reproducir con el icono ▶/||).
- ▶▶: Avance rápido/Localización progresiva (Vuelve para reproducir con el icono ▶/||).
- : Parada

■ Reproducción de tarjeta

- Ajuste al modo de reproducción de imagen.

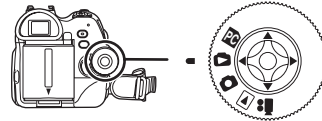

- 1 Actúe en la palanca de mando.



- ◀◀: Reproducción de la imagen anterior.
- ▶▶: Reproducción de la siguiente imagen.
- ▶/■: Diapositiva (Reproduce por orden las imágenes fijas en la tarjeta), inicio/parada

**Panasonic Consumer Electronics Company,
Division of Panasonic Corporation of North America**

One Panasonic Way, Secaucus, NJ 07094

Panasonic Puerto Rico, Inc.

Ave. 65 de Infantería, Km. 9.5, San Gabriel Industrial Park, Carolina, Puerto Rico 00985

Panasonic Canada Inc.

5770 Ambler Drive, Mississauga, Ontario, L4W 2T3



LSQT0860 A
S1204Nm0

© 2004 Matsushita Electric Industrial Co., Ltd.